

 TUROGIZE

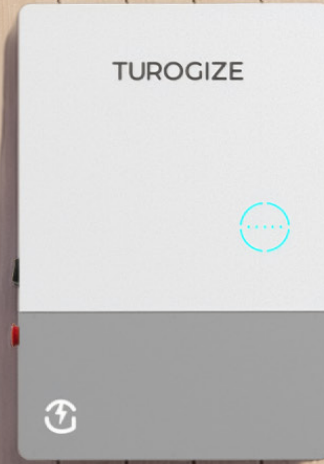

TGPower
Home Energy Storage System
Hybrid Inverter

USER MANUAL

TGP-INV-HY-LV-11.5

Legal Notice

TuroGize has made every effort to ensure the accuracy and completeness of this manual. However, this manual may be changed and revised due to product enhancements or user feedback.

TuroGize reserves the right to modify this manual without prior notice at any given time. The latest version of this manual can be found by visiting the TuroGize official website www.TuroGize.com or scanning the QR Code below.



Warranty

Follow the installation instructions in this manual to ensure warranty compliance and reliability.

The complete warranty terms and conditions can be accessed at www.TuroGize.com.

A brief introduction to our warranty:

This Limited Warranty covers defects in materials and workmanship under normal residential use for a period of 10 years from the date of purchase.

Warranty service may include repair or replacement of defective components.

TuroGize as the brand owner, the warranty service is delivered through the authorized service partners and technical support channels.

The warranty remains valid only if all the following conditions are met:

1. The product is properly installed, wired, and commissioned in accordance with:
 - Canadian Electrical Code (CEC)
 - Provincial/territorial regulations
 - Local authorities having jurisdiction (AHJ)
2. Installation is performed by licensed electricians.
3. Installation and operation follow the User Manual and remain within all specified operating limits.
4. The inverter is used in compatible systems and with approved accessories.
5. The product's configuration, software, and firmware must remain unchanged and be updated solely through official TuroGize channels (App Store / Google Play).
6. The product label and serial number remain intact and unaltered.

This warranty applies only to defects in the product itself. It does not apply to the following situations:

- Damage caused by improper installation, wiring, or configuration
- Damage resulting from failure to comply with electrical codes or AHJ requirements
- Use outside product specifications (temperature limits, SOC limits, parallel limits, etc.)
- Use with third-party equipment not approved by TuroGize.
- Physical damage during the user application, due to moving, dropping, or other shock
- Damage caused by environmental exposure beyond the product's specified limits (salts, chemicals, etc.)
- Unauthorized disassembly, modification, or repair
- Damage caused by fire, flood, lightning, power surges, utility grid issues, or other force majeure events
- Capacity loss or normal aging
- Costs related to labor, transportation, or removal/reinstallation unless otherwise specified

Contact Information

If you have technical queries or any questions concerning our products, please find the contact regional representatives on www.TuroGize.com, or email: support@turogize.com.

Contents

1	About This Manual	1
1.1	Purpose	1
1.2	Audience	1
1.3	Validity	1
2	Safety Information	2
2.1	Safety Symbols	2
2.2	Additional Symbols	2
2.3	Safety Instructions	4
3	Transportation and Storage	6
3.1	Transportation Requirements	6
3.2	Storage Requirements	6
4	Product Introduction	7
4.1	Product Overview	7
4.2	Product Dimensions	8
4.3	LED Indicators	09
4.4	Protection Circuitry and Controls	11
4.4.1	AFCI	11
4.4.2	RSD	11
4.4.3	External Emergency Power Off Switch (Optional)	12
4.5	Working Modes	13
5	System Overview	16
5.1	Basic Diagram	16
5.2	Retrofit Diagram	17
5.3	Unacceptable Diagram	19
6	Installation Instruction	20
6.1	Unpacking	20
6.2	Installation Tools	21
6.3	Installation Requirements	21
6.4	Installation Steps	22
7	Electrical Connection	23
7.1	Overcurrent Protection Requirement	23
7.2	Recommended Cable List	23
7.3	Opening the Wiring Box Cover	24
7.4	PV Cable Connection	24
7.5	Battery Cable Connection	25
7.6	AC Cable Connection	26
7.6.1	GEN Port Limit	27
7.6.2	Generator Control	28
7.6.3	Heat Pump Control	28

7.7	Communication Cable Connection.....	28
7.7.1	Smart Meter and CT Connection	29
7.7.2	DI Connection	30
7.7.3	DO Connection.....	30
7.7.4	BMS Connection.....	32
7.8	Parallel Connection.....	33
7.8.1	Parallel System 1.....	34
7.8.2	Parallel System 2.....	37
7.9	DTS Connection	40
7.9.1	TGP-ACC-DTS.....	40
7.10	Installing the Wiring Box Cover.....	44
8	System Commissioning.....	45
8.1	Preparation	45
8.2	System Power-on.....	45
9	TGPower Cloud	46
9.1	Connect to the DTS.....	46
9.2	Start Commissioning.....	48
9.3	Set System Parameters.....	53
9.3.1	Set Advanced Parameters	53
9.3.2	Set Export Management Parameters.....	56
9.3.3	Set Working Mode.....	57
9.3.4	Set Dry Contact Function.....	59
9.4	Upgrade the Firmware.....	62
9.5	ESS Operating Modes Setting	64
9.5.1	Export Only Mode.....	64
9.5.2	Import Only Mode.....	64
9.5.3	APP Setting.....	64
10	System Maintenance	66
10.1	System Power-off.....	66
10.2	Routine Maintenance	66
10.3	Troubleshooting	67
11	Decommissioning	70
11.1	Removing the Product.....	70
11.2	Packing the Product.....	70
11.3	Disposing of the Product	70
12	Technical Datasheet.....	71
13	Appendix 1: Power Quality Response Modes	73
14	Appendix 2: HECO.....	77

1 About This Manual

1.1 Purpose

This manual provides information on the installation, electrical connections, operation, and maintenance of TGPover Hybrid inverter.

Please consider the following before installation:

- Carefully read this manual before operation.
- Keep this manual for reference.

1.2 Audience

This manual is intended for use by qualified persons only. Qualified persons must have the following skills:

- Knowledge of how a battery works.
- Knowledge of how an inverter works.
- Training in how to deal with the dangers and risks associated with the installation, maintenance, and use of electrical devices.
- Training in the installation, commissioning, and maintenance of electrical devices.
- Knowledge of and compliance with all applicable laws, standards, and directives.

1.3 Validity

This manual is valid for:





- TGP-INV-HY-LV-11.5

2 Safety Information

Before installing, operating, commissioning, and maintaining the inverter, please carefully read the safety rules and usage instructions in this document as failure to do so may result in safety hazards or device damage. Safety instructions in this manual cannot cover all precautions that should be taken. Please consider the actual conditions on site when performing operations. Any damage caused by a violation of the safety instructions in this manual shall not be the responsibility of TuroGize.



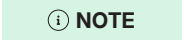

2.1 Safety Symbols







Safety symbols are used in this manual as follows:

Symbol	Description
	This symbol indicates potential risks that, if not avoided, may lead to death or serious physical injury.
	This symbol indicates potential risks that, if not avoided, may lead to personal injury or device damage.
	This symbol indicates potential risks that, if not avoided, may lead to device malfunctions or financial losses.
	This symbol indicates potential risks that, if not avoided, may lead to minor injury or damage to the equipment.
	This symbol indicates an important step or tip that leads to the best results but is not safety- or damage-related.

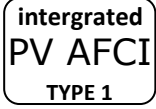
2.2 Additional Symbols

The product label contains the following symbols with their meanings described below:

Symbol	Usage
	Caution Failure to observe any warnings contained in this manual may result in injury.
	Danger to life due to high voltages Only qualified personnel can open and maintain the inverter.
	Hot surface Burn danger due to hot surface that may exceed 60°C.
	After the inverter is turned off, wait for at least 5 minutes before opening the inverter or touching live parts.
	The product shall not be disposed of as household waste.

	<p>Observe the documentation</p> <p>Read and understand all documentation supplied with the product.</p>
	<p>Supports Type 1 DC Arc Detection on PV side.</p>
	<p>CSA Marking for the United States of America and Canada.</p>
	<p>This side up! This package must always be transported, handled, and stored in such a way that the arrows always point upwards.</p>
	<p>Fragile - The package/product should be handled carefully and should never be tipped over or slung.</p>
	<p>Keep dry! The package/product must be protected from excessive humidity and must be stored under cover.</p>
	<p>No more than six (6) identical packages are to be stacked on each other.</p>

2.3 Safety Instructions

SAVE THESE INSTRUCTIONS-This manual contains important instructions for models TGP-INV-HY-LV-11.5, which should be followed during the installation and maintenance of the inverter.

For the purpose of preventing personal injury and property damage, as well as ensuring the long-term operation of the product, please read and follow all the instructions and cautions on the inverter and in this user manual during installation, operation, and maintenance.

Safety instructions in this manual cannot cover all precautions that should be taken. Please consider the actual conditions on site when performing operations. Any damage caused by a violation of the safety instructions in this manual shall not be the responsibility of TuroGize.

DANGER

Danger to life from electric shock

- Before performing any work on the inverter, disconnect all DC and AC power from the inverter and wait for at least 5 minutes. The hazardous voltage will exist for up to 5 minutes after disconnection from the power supply.
- Never insert or remove the AC or DC connections when the inverter is running.
- Any live parts connected to battery ports cannot be touched before removing all the power from the inverter for 5 minutes, because there is still danger to life even battery voltage is lower than 60 V.
- Do not touch DC conductors or any non-isolated cable ends.
- The mounting location must be inaccessible to children.
- Never touch either the positive or negative pole of the PV connecting device. Strictly prohibit touching both at the same time.

WARNING

Risk of burns from hot surfaces

- The surface of the inverter might exceed 60°C (140°F), and touching the surface may result in burns.
- Do not touch hot surfaces before it cools down.
- Only authorized service personnel are allowed to install the inverter or perform servicing and maintenance.
- All powers, both AC and DC, should be disconnected from the inverter before attempting any maintenance, cleaning, or working on any circuits connected to the inverter.
- Attempting to service the inverter yourself may result in a risk of electric shock or fire and will void your warranty.
- Keep away from flammable and explosive materials to avoid fire disasters.
- The installation place should be away from humid or corrosive substances.
- The unit contains capacitors that remain charged to a potentially lethal voltage after the mains, battery, and PV supply have been disconnected.
- When accessing the internal circuit of the inverter, wait for at least 10 minutes after disconnecting the power.

⚠ CAUTION

- The inverter has a transformerless design on the PV side. Neither positive nor negative terminals of PV panels should be grounded.
- The frames of PV panels should be grounded for safety reasons.
- Ensure that existing wiring is in good condition and no wire is undersized.
- Do not disassemble any parts of the inverter which are not mentioned in the installation.
- Authorized service personnel must use insulated tools when installing or working with this equipment.
- PV modules shall have an IEC 61730 class A rating and should be certified to UL 61730-1 and UL 61730-2 standards.

NOTICE

- The minimum rated temperature of the wire used is 90°C (194°F).
- All electrical connections must be in accordance with local and national standards.
- Only with permission of the local utility grid company, the inverter can be connected to the utility grid.
- Do not open the inverter cover or change any components without authorization, otherwise, the warranty commitment for the inverter will be invalid.
- Appropriate methods must be adopted to protect the inverter from electrostatic discharge; any damage caused by ESD is not warranted by the manufacturer.
- Prior to the application, please read this section carefully to ensure correct and safe application. Please keep the user manual properly.
- The manual contains no instructions for user-serviceable parts. See Warranty for instructions on obtaining service.
- If an error occurs, contact your local distributor or qualified electricians.

3 Transportation and Storage

3.1 Transportation Requirements

- Place the inverters into the original packaging or specially designed transport packaging. The packaging materials should have sufficient strength and cushioning performance to prevent damage caused by collisions and squeezes during transportation.
- Secure the inverter firmly inside the packaging to avoid displacement during transportation. For large or heavy inverters, additional fixing devices may be required.
- Maintain stability and avoid sudden starts, stops, or excessive vibration during transportation.
- Observe the safety symbols on the package of the inverter before transportation.
- Pay attention to the weight of inverter. Be cautious to avoid injury when moving. Handle the inverter according to the personnel quantity required by local regulations.
- Wear protective gloves when moving the equipment by hand to prevent injuries.
- Hold the handle position and the bottom position of the inverter when lifting up the inverter. Keep the inverter horizontal in case it falls.
- Use professional handling equipment, and it is essential to ensure that the operators possess the requisite operational skills and experience.

3.2 Storage Requirements

- Do not unpack the inverter if it is not used immediately.
- The storage temperature should be between -40°C (-40°F) and 70°C (158°F), and the relative humidity should be between 5% and 95%, without condensing.
- Store inverters in a clean and dry place to protect them from dust and moisture.
- The storage place should be well ventilated to ensure air circulation and avoid overheating of the equipment.
- Do not store the products in places exposed to direct sunlight, wet by rain, or with strong electric fields.
- Do not store inverters in places with chemically corrosive substances or where there are pests and rodents.
- Inverters should be repackaged in their original packages with desiccants retained.
- To avoid personal injury or device damage, stack inverters with caution to prevent them from falling.
- The packages should not be tilted or inverted.
- Do not place heavy objects on the inverters to prevent damage to the equipment housing or internal components.
- During the storage period, inverters should be checked regularly, and it is recommended to check the inverter once every three months. Replace the packing materials damaged by insects or rodents in a timely manner.
- If inverters have been stored for two years or longer, they must be inspected and tested by professionals before being put into use.

4 Product Introduction

4.1 Product Overview

The TGP-INV-HY-LV-11.5 inverter is a high-performance split-phase energy storage inverter with excellent reliability. The intelligent EMS function supports self-consumption, economy, and backup modes for multi-scenario applications. Monitoring management through TGPower Cloud allows users to remotely diagnose and track the system performance over time, offering superior energy production.

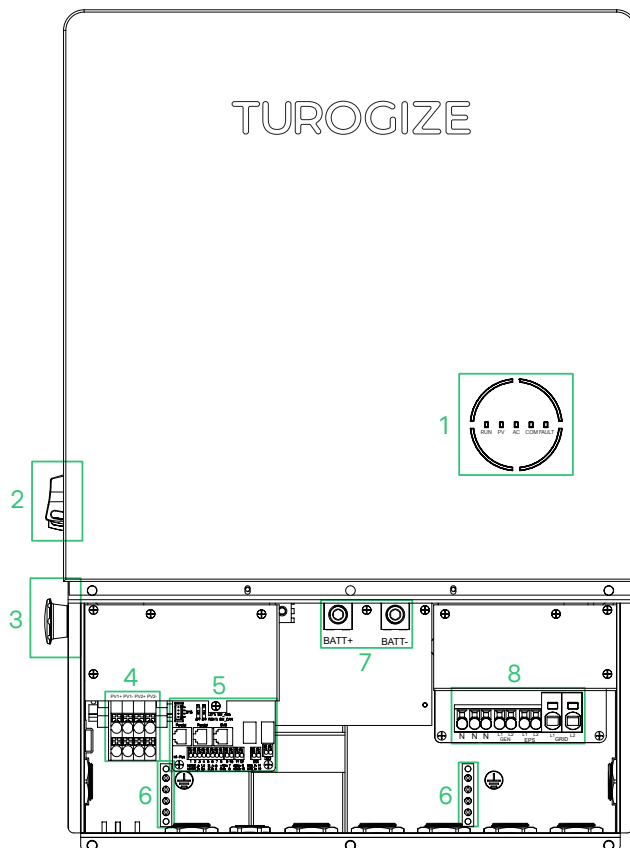

* The image shown here is for reference only. The actual product received may differ.

Object	Description
1	LED Indicators
2	DC Switch ⁽¹⁾
3	Rapid Shutdown Switch
4	PV Terminals ⁽²⁾
5	Communication Port
6	Grounding Bar
7	Battery Terminals
8	AC Terminals

(1) Only for TGP-INV-HY-LV-11.5 inverter.

(2) Only for TGP-INV-HY-LV-11.5 inverter.

4.2 Product Dimensions

TGP-INV-HY-LV-11.5

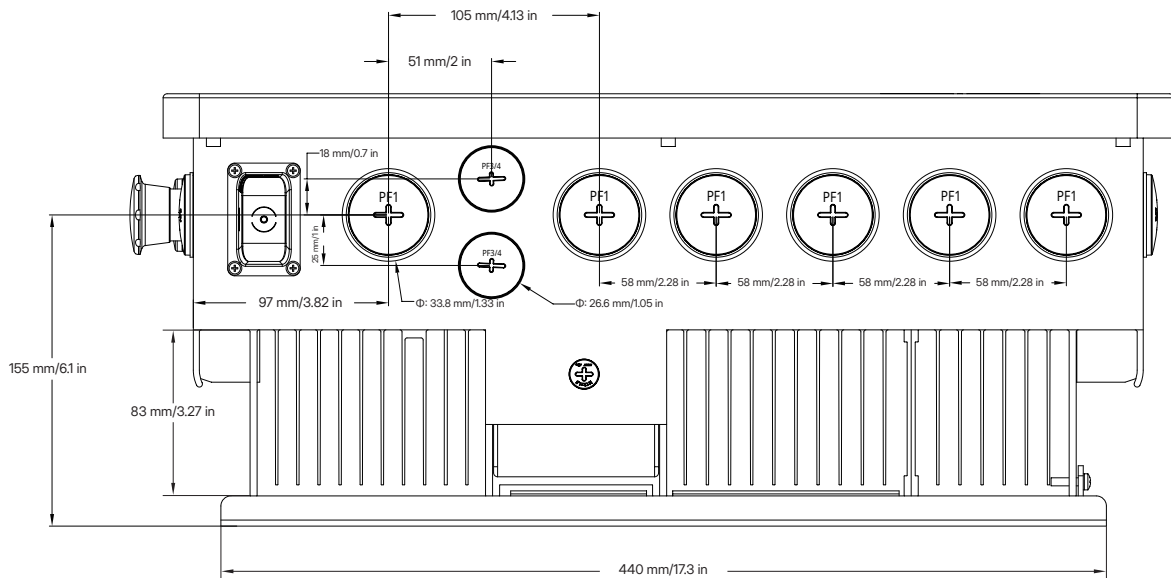
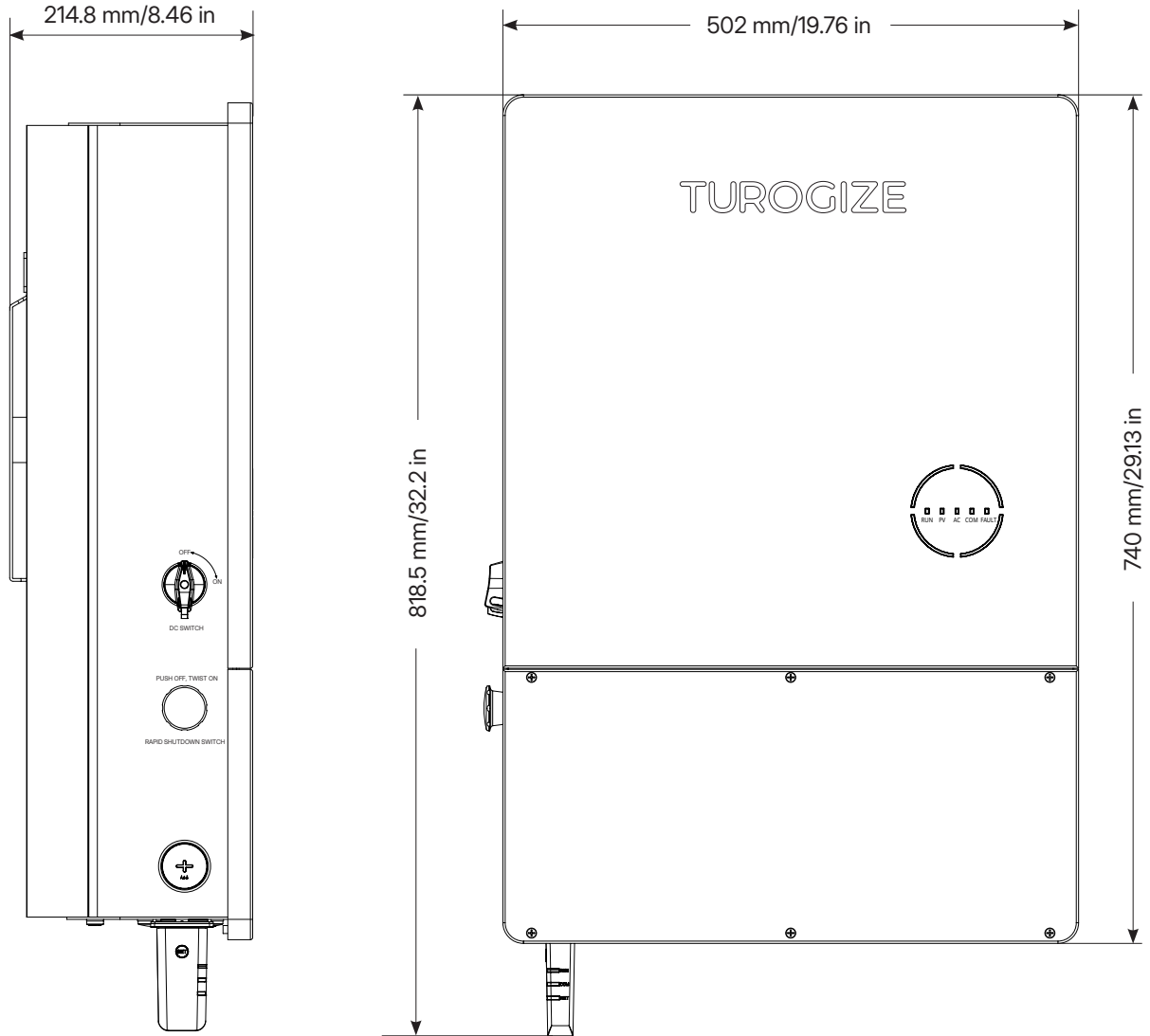

4.3 LED Indicators

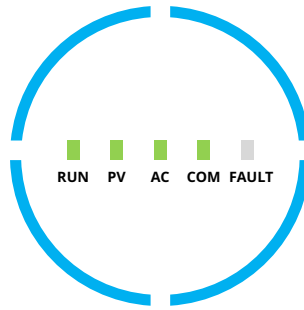

Indicator	Status	Explanation
SOC		Full circle LEDs on – SOC is 75-100%; battery is discharging or in standby Full circle LEDs blink – SOC is 75-100%; battery is charging
		3/4 circle LEDs on – SOC is 50-75%; battery is discharging or in standby 3/4 circle LEDs blink – SOC is 50-75%; battery is charging
		2/4 circle LEDs on – SOC is 25-50%; battery is discharging or in standby 2/4 circle LEDs blink – SOC is 25-50%; battery is charging
		1/4 circle LED on – SOC is 0-25%; battery is discharging or in standby 1/4 circle LED blinks – SOC is 0-25%; battery is charging
		Full circle LEDs off – No BMS communication

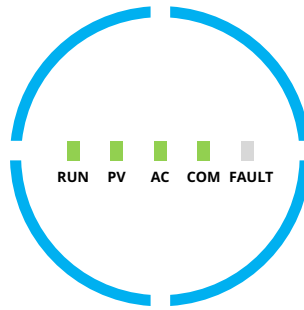

Indicator	Status	Explanation
RUN		Off – Inverter is shut down Blink 1 – Inverter is booting Blink 2 – Inverter is in bypass mode On – Inverter is turned on
PV		Off – PV voltage is low Blink 1 – PV power is low On – PV is generating power
AC		Off – Grid is disconnected and EPS is off, or a grid fault occurs Blink 1 – Grid is disconnected but EPS is on On – Grid is connected
COM		Off – Communication error of both meter and BMS Blink 1 – Communication failed to meter Blink 2 – Communication failed to BMS On – Both meter and BMS communications are normal
FAULT		Off – No fault On - A fault occurs Blink 1 – EPS port overload Blink 2 – ISO/RCD fault Blink 3 – Arc fault

4.4 Protection Circuitry and Controls

The TuroGize TGP-INV-HY-LV-11.5 inverter is equipped with arc fault circuit breakers (AFCI) and rapid shutdown (RSD) for the protection circuit and control to meet the relevant codes and standards.

4.4.1 AFCI

According to 2011 NEC Section 690.11, photovoltaic systems operating at 80 volts DC or greater between any two conductors shall be protected by a listed PV arc-fault circuit interrupter or other system components listed to provide equivalent protection. The AFCI function is integrated into the

TGP-INV-HY-LV-11.5 inverter. Once an arc fault is detected, the corresponding error and time will be reported in the App. Within 24 hours, when the first four faults occur, the inverter will automatically clear the alarms and restart; when the fifth fault occurs, the inverter will shut down, and cannot automatically clear the alarm and restart. The inverter will resume operation after inspecting and repairing the arc fault position on-site, and manually clearing the alarm.

4.4.2 RSD

The TGP-INV-HY-LV-11.5 inverter integrates the transmitter HT10. When paired with TuroGize rapid shutdown HRSD and powered on, HT10 sends a "permission to operate" signal to HRSD that is connected to the PV modules. Once HRSD receives this signal, it will start to work and enable PV modules to be connected in series to the hybrid inverter, thus producing power. When HRSD gets this signal, it will start to work and allow the string voltage to ramp up. When the HRSD loses this signal, it will be in the standby state, and the HRSD only outputs around 1 Vdc.



Rapid Shutdown Initiation Process:

1. Press the switch button to turn off the internal transmitter. This will initiate rapid shutdown of the PV (ramps the PV voltage down).
2. Twist the switch clockwise to turn on the transmitter. This will bring the PV voltage back up to normal.

NOTE

The rapid shutdown will only be initiated if HRSD has been installed on the PV modules. Without the HRSD, rapid shutdown is not possible.

4.4.3 External Emergency Power Off Switch (Optional)

If the inverter is installed in a place where it is inaccessible to first responders, an external Emergency Power Off (EPO) switch must be installed to manually shut down the system in case of emergency.

The external EPO switch is not provided by TuroGize and should be purchased separately. It must meet the requirements as follows.

- An ON/OFF position and an ON/OFF position indicator.
- A protection degree of NEMA 3R or above.
- It should be a normally closed (NC) switch.
- The installation location should be readily accessible.

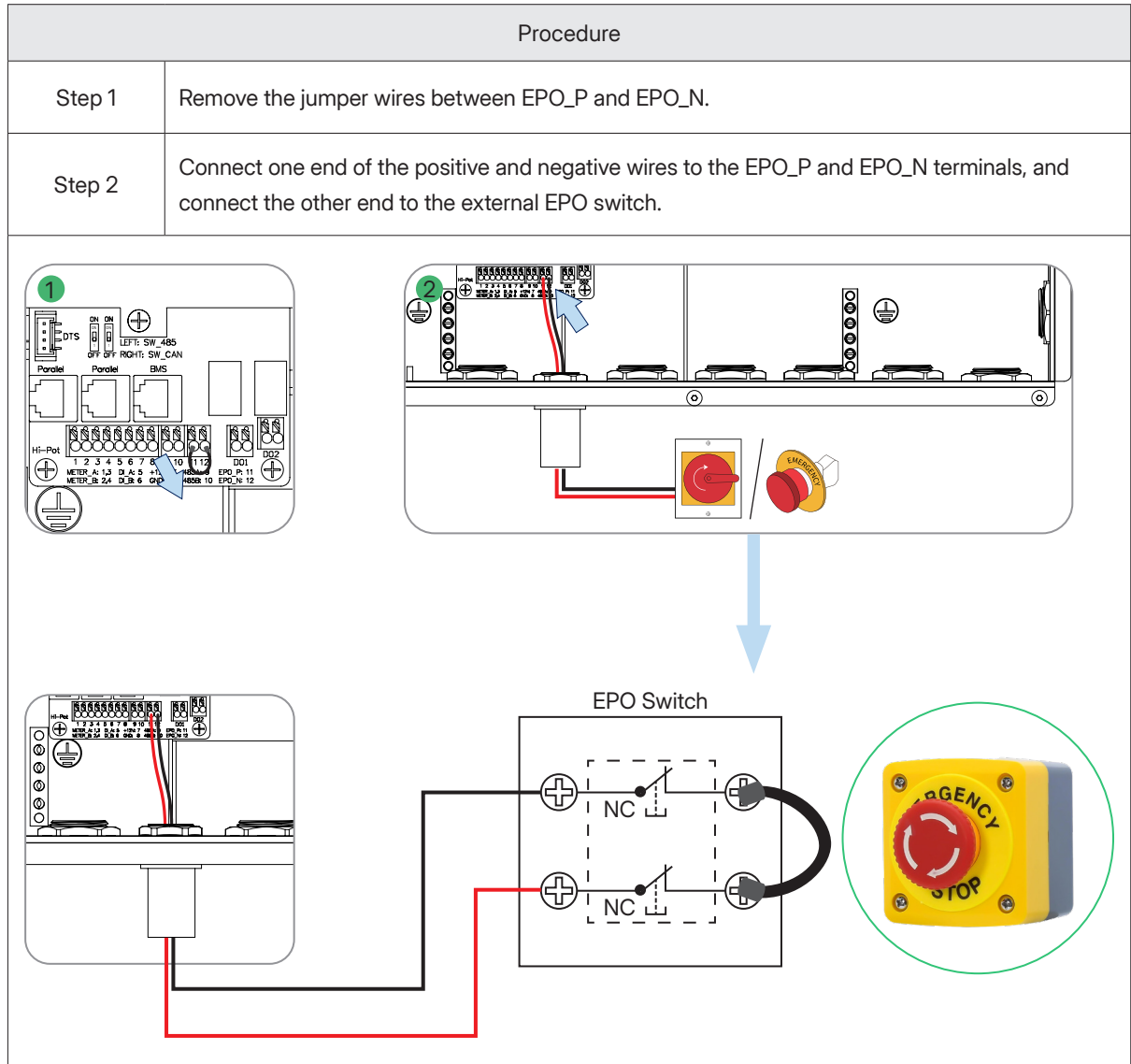

NOTE
 If an external Emergency Power Off switch is not needed, please do not remove the jumper wires.

4.5 Working Modes

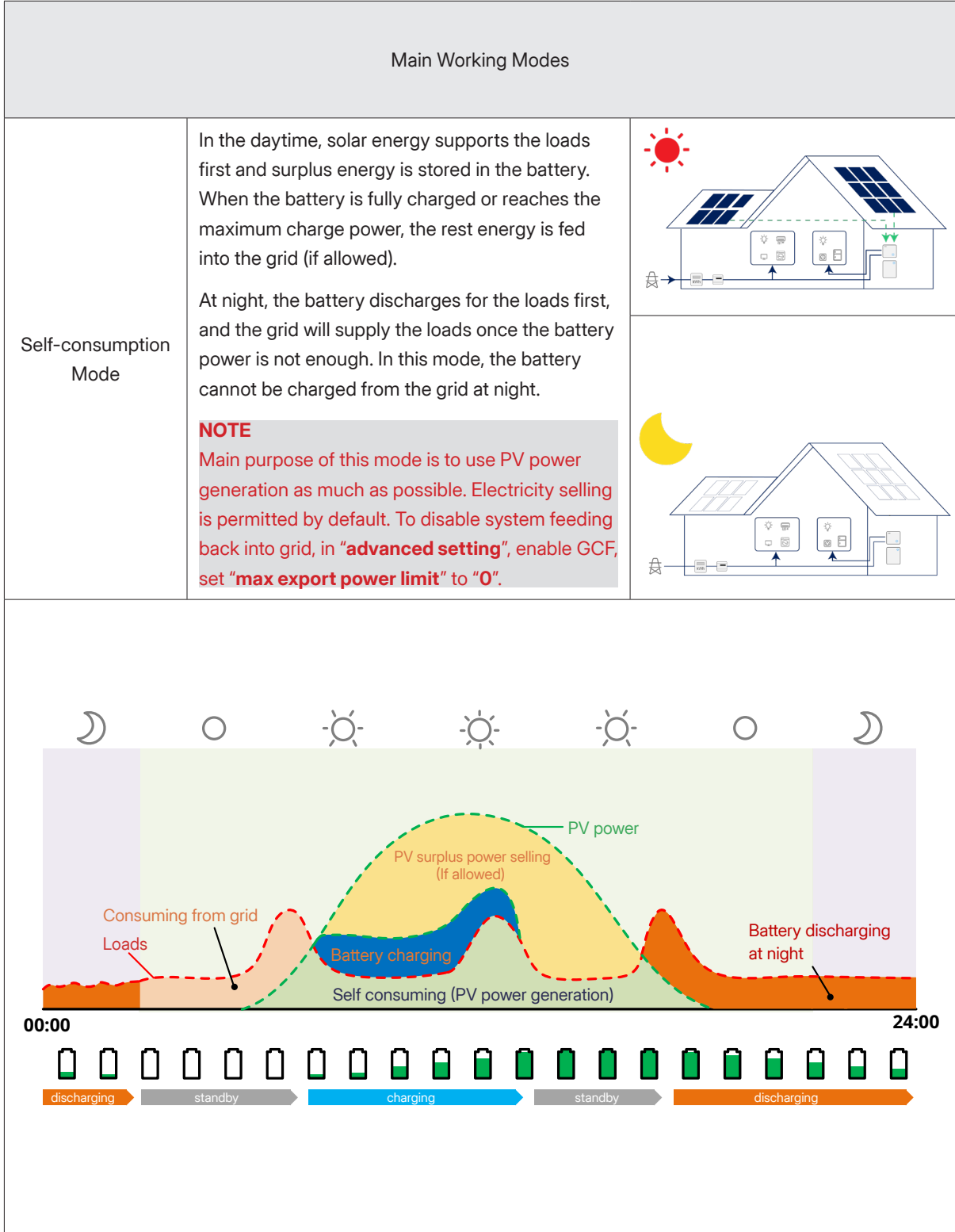

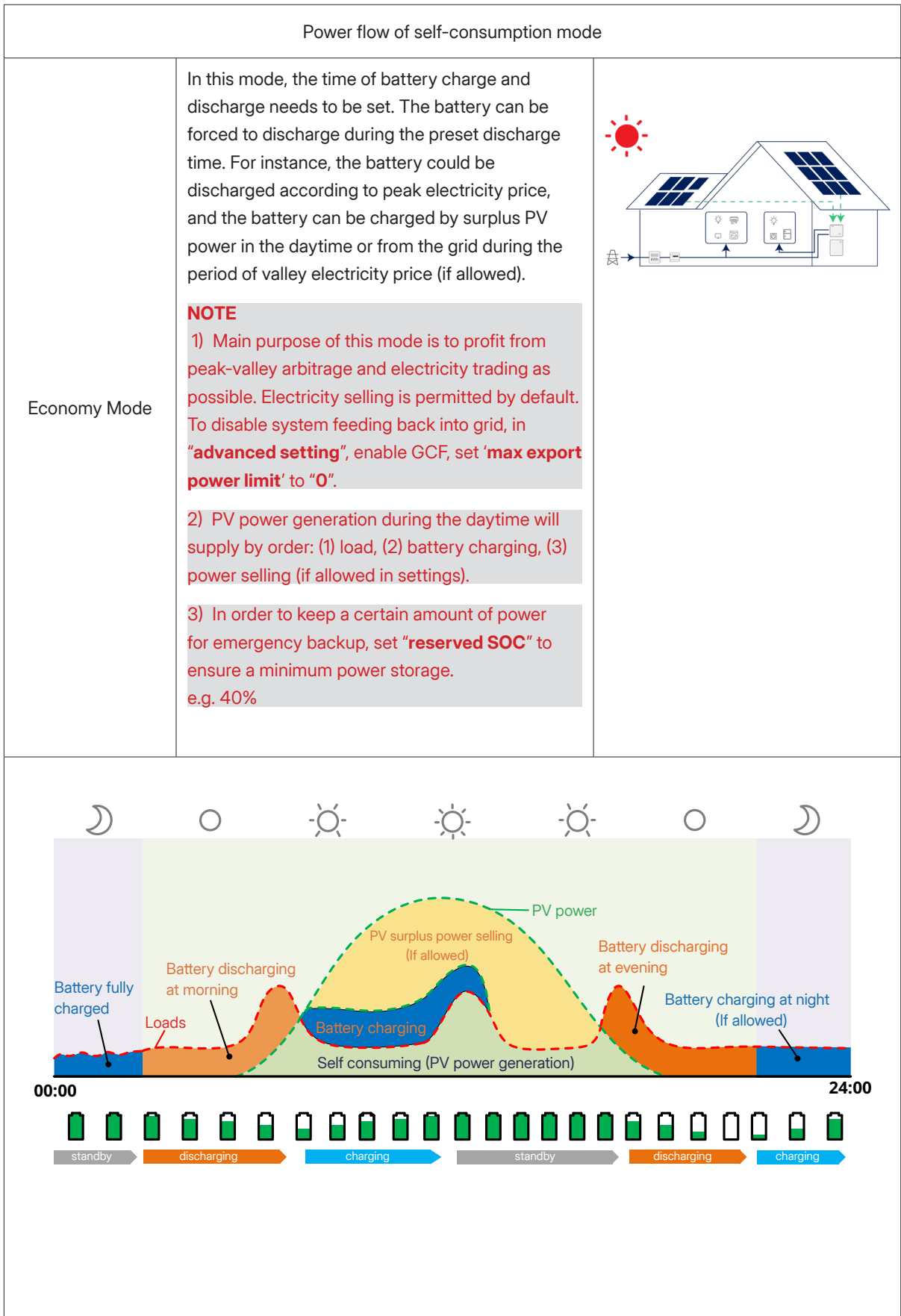

Power flow of economy mode

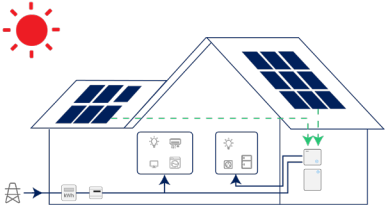
<p>Backup Mode</p>	<p>In case of frequent power outages, a backup power SOC can be configured, which ensures that the battery always has enough energy to handle critical loads.</p> <p>NOTE Main purpose of this mode is to reserve the battery capacity above a certain percentage set in the settings. When battery capacity is lower by more than 7% than the set value, battery will start to charge automatically.</p>	
--------------------	--	---

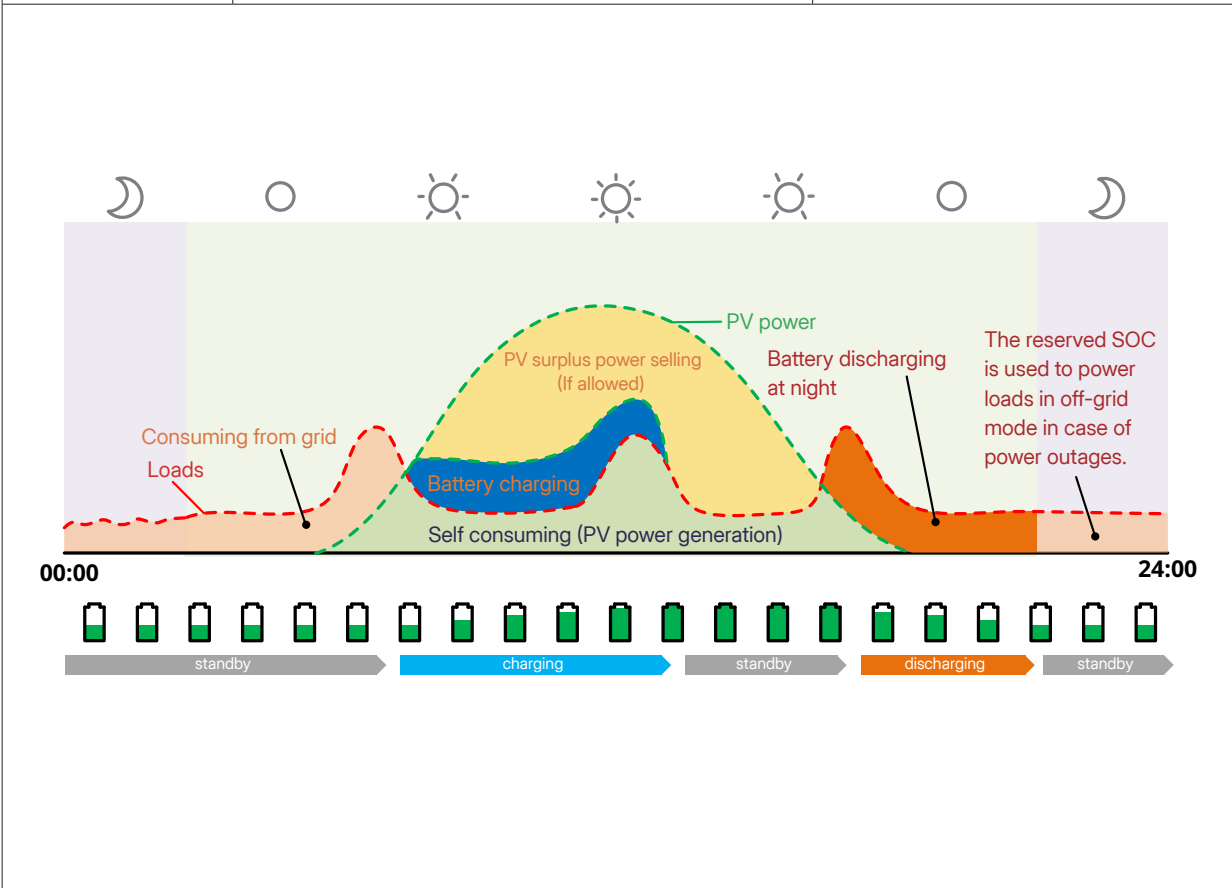

5 System Overview

NOTICE

- The following diagrams are only intended to explain system architecture. Please comply with local laws and regulations.
- TGP-INV-HY-LV-11.5 support both Li-ion and lead-acid batteries. Only qualified personnel can install, operate, and maintain the inverter and the battery. If there are any problems, please contact TuroGize for technical support.
- Please refer to <https://www.TuroGize.com> for the compatible Li-ion battery list. The user should first contact TuroGize for technical consultation and obtain official confirmation before installing any battery not included in the official published list.

5.1 Basic Diagram

TGP-INV-HY-LV-11.5

The TGP-INV-HY-LV-11.5 inverter can be connected to a battery and PV panels to form a PV Energy Storage System (ESS). In the event of a grid outage, it can be used as an emergency power supply (EPS) through the self-consumption of solar energy. It can form a hybrid system for a new installation or an AC-coupled system to retrofit existing installations.

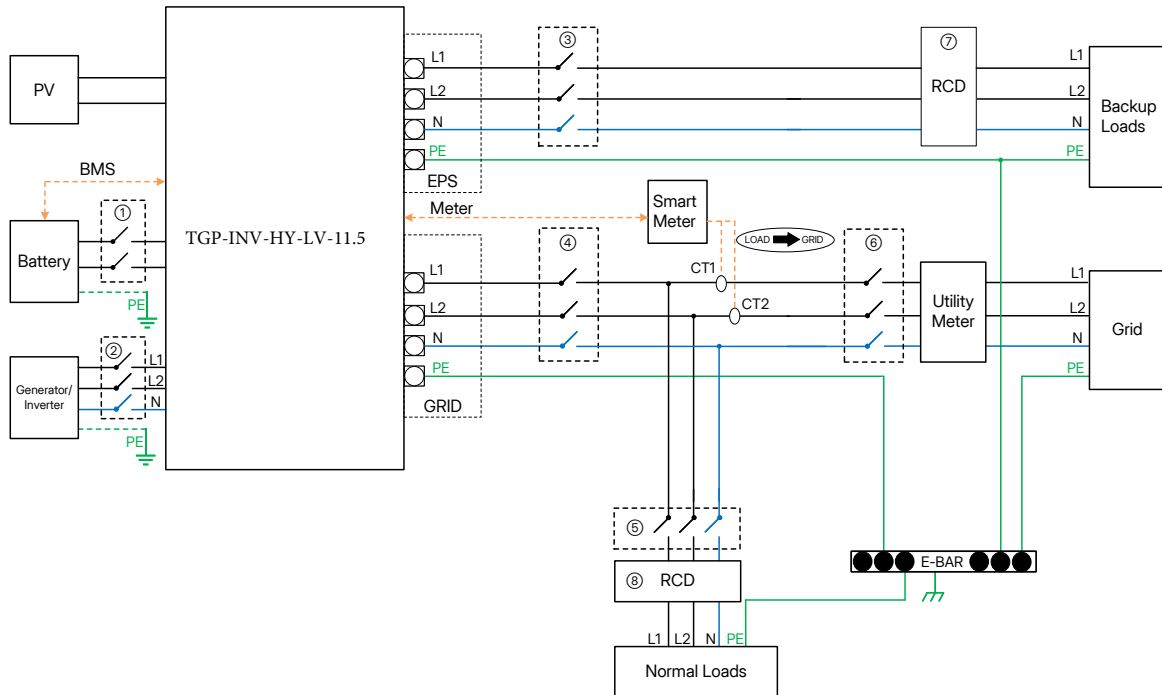

NOTE

- If the battery integrates a readily accessible internal DC breaker or fuse, no additional ① DC breaker or fuse is required.
- If the generator has integrated a readily accessible internal AC breaker, no additional ② AC breaker is required.
- ⑦⑧ 30 mA RCD is recommended but not mandatory; please comply with local regulations.

5.2 Retrofit Diagram

Scenario 1 DC COUPLING SYSTEM AND PARTIAL HOME BACKUP WITH GENERATOR

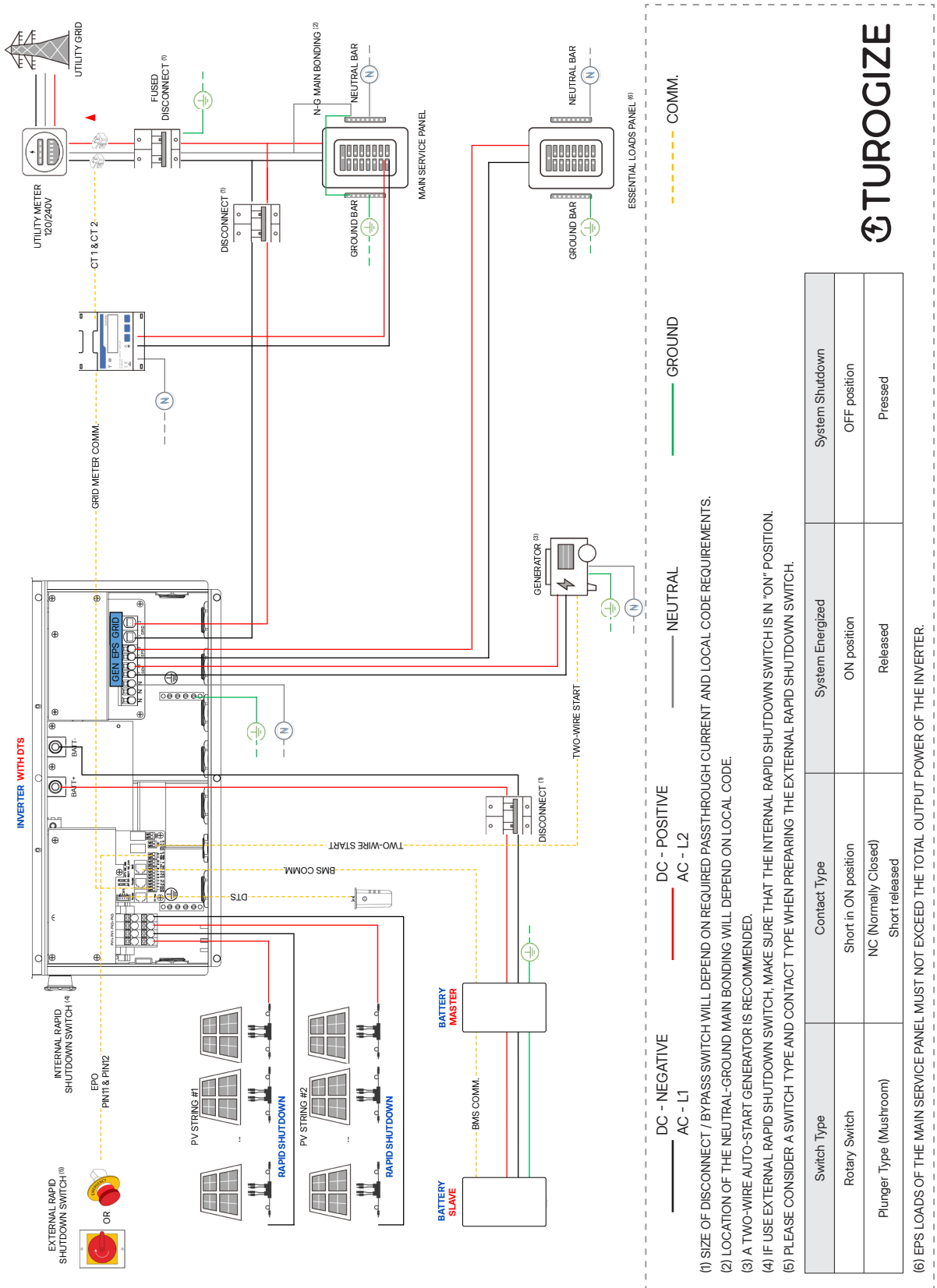

Switch Type	Contact Type	System Energized	System Shutdown
Rotary Switch	Short in ON position	ON position	OFF position
Plunger Type (Mushroom)	NC (Normally Closed) Short released	Released	Pressed



Scenario 2 DC COUPLING SYSTEM AND WHOLE HOME BACKUP WITH GENERATOR

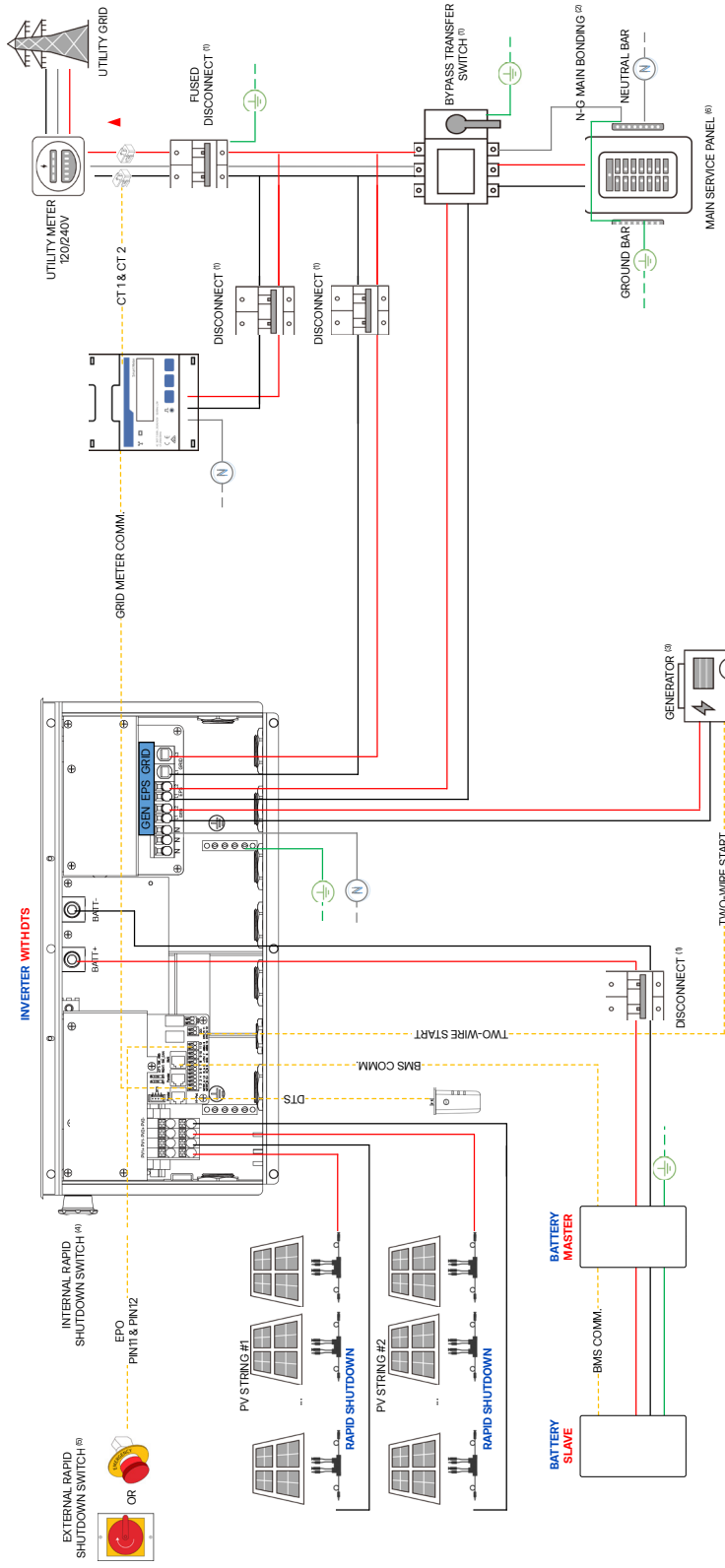

— DC - POSITIVE
— DC - NEGATIVE
— AC - L1
— AC - L2
— NEUTRAL
— GROUND
- - - COMM.

- (1) SIZE OF DISCONNECT / BYPASS SWITCH WILL DEPEND ON REQUIRED PASSTHROUGH CURRENT AND LOCAL CODE REQUIREMENTS.
- (2) LOCATION OF THE NEUTRAL-GROUND MAIN BONDING WILL DEPEND ON LOCAL CODE.
- (3) A TWO-WIRE AUTO-START GENERATOR IS RECOMMENDED.
- (4) IF USE EXTERNAL RAPID SHUTDOWN SWITCH, MAKE SURE THAT THE INTERNAL RAPID SHUTDOWN SWITCH IS IN "ON" POSITION.
- (5) PLEASE CONSIDER A SWITCH TYPE AND CONTACT TYPE WHEN PREPARING THE EXTERNAL RAPID SHUTDOWN SWITCH.

Switch Type	Contact Type	System Energized	System Shutdown
Rotary Switch	Short in ON position NC (Normally Closed) Short released	ON position	OFF position
Plunger Type (Mushroom)		Released	Pressed

(6) EPS LOADS OF THE MAIN SERVICE PANEL MUST NOT EXCEED THE TOTAL OUTPUT POWER OF THE INVERTER.



5.3 Unacceptable Diagram

Avoid the following installation types to prevent damage to the system or the inverter.

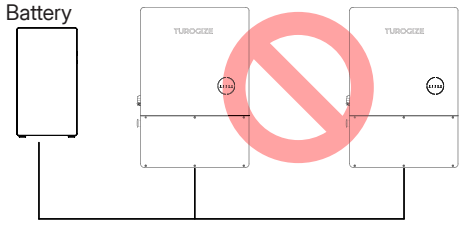

One battery cannot be connected to multiple inverters.

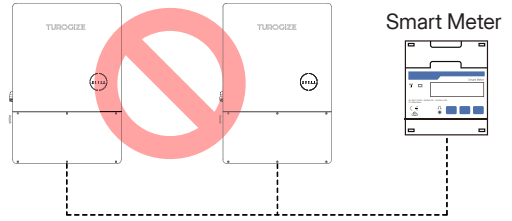

One meter cannot be connected to multiple inverters and different CTs cannot be connected to the same line cable.

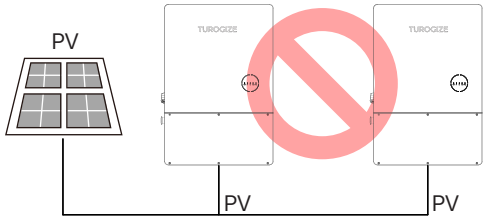

Single PV cannot be connected to multiple inverters.

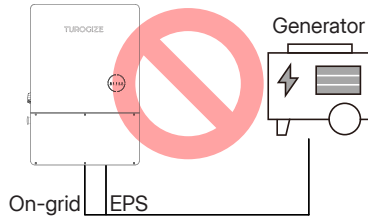

Neither EPS or on-grid port can be connected to generator directly.

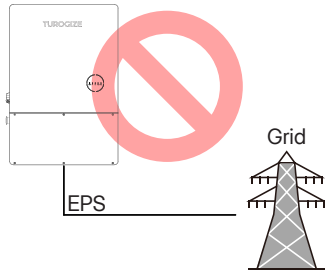

EPS port cannot be connected to grid directly.

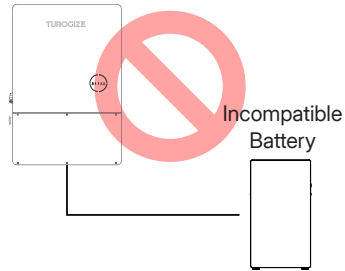

Incompatible battery cannot be connected to battery port.

NOTE

The following two diagrams are acceptable if the inverters are connected in parallel.

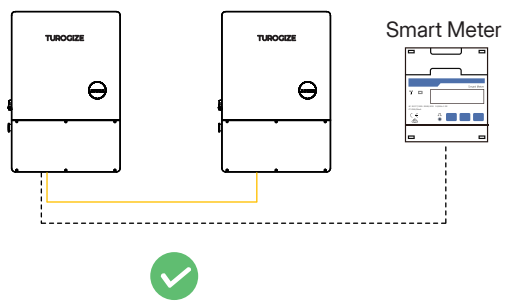
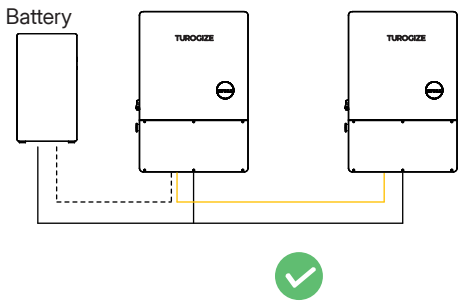

6 Installation Instruction

6.1 Unpacking

Please ensure that none of the components listed below are missing or damaged upon receipt of the hybrid or AC-coupled inverter.

TGP-INV-HY-LV-11.5

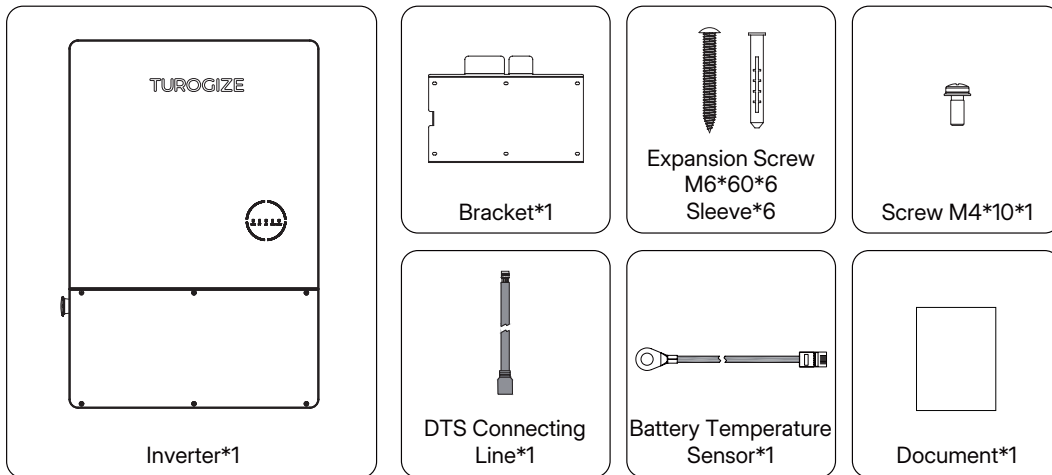

Accessories Packing List (Optional)

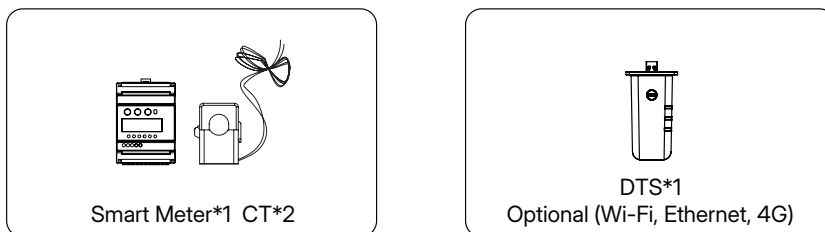

6.2 Installation Tools

The following tools are recommended in the installation process, and other auxiliary tools can also be used on site if necessary.

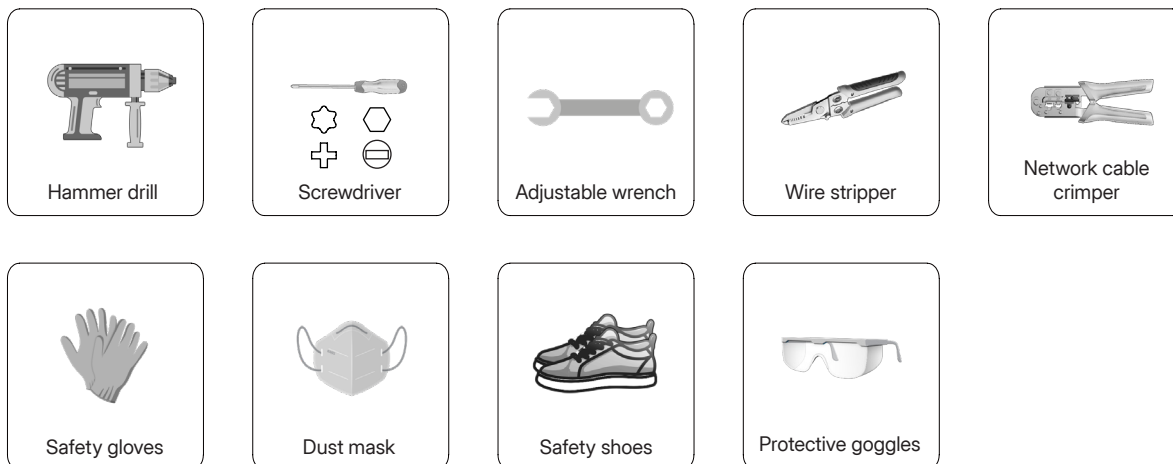

6.3 Installation Requirements

⚠ WARNING

- Make sure there is no electrical connection before installation.
- To avoid electric shock or other injuries, make sure that holes are not drilled into any electrical parts or plumbing installations.

NOTICE

Make sure the inverter is correctly installed according to the following list. Any incorrect installation would require a risk assessment.

- The inverter installation should be protected by shelter from direct sunlight or bad weather such as snow, rain, or lightning.
- The inverter should be installed on a solid surface that is suitable for the inverter’s dimensions and weight.
- The inverter should be installed vertically or at a maximum back tilt of 15°. Leave enough space around the inverter according to the figure below.





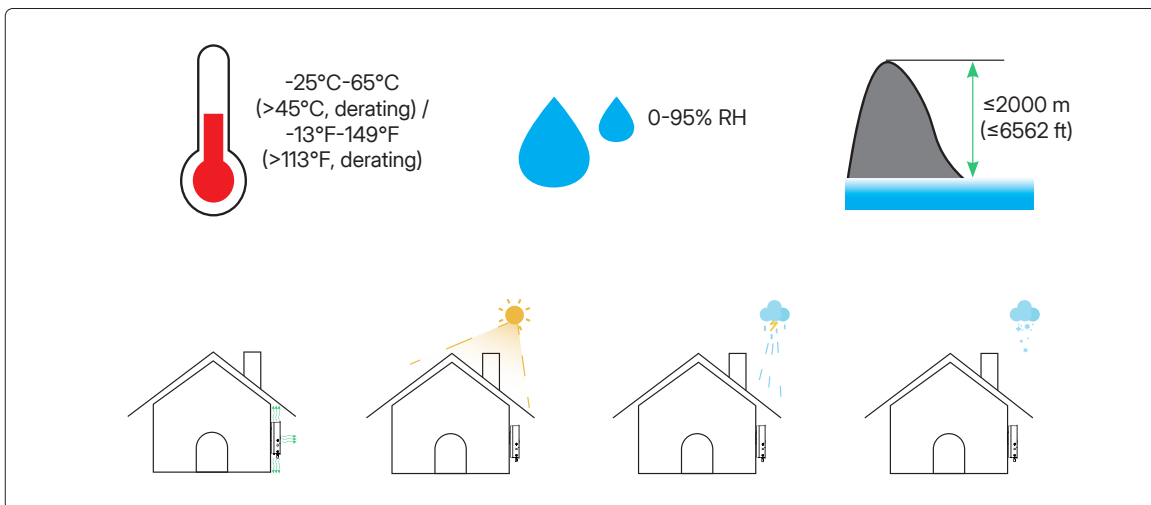

- The inverter should be installed in an environment with good ventilation and heat dissipation conditions.
- The ambient temperature should be between -25°C (-13°F) and 45°C (113°F). High ambient temperatures will cause power derating of the inverter.
- The relative humidity should be less than 95%, without condensing.
- The inverter should be installed at eye level for convenient maintenance.
- The product label on the inverter should be visible after installation.
- The inverter should be installed far from flammable materials.

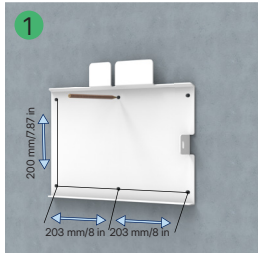
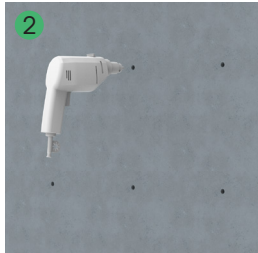
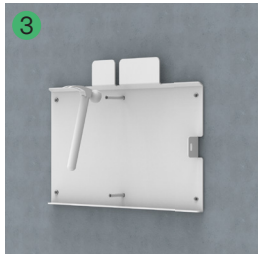

6.4 Installation Steps

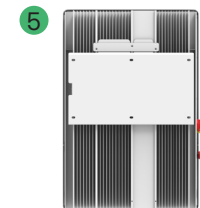
Install the inverter on the wall using the provided wall-mounting bracket and expansion plug sets.

Procedure	
Step 1&2	a. Position the bracket against the wall and mark the 6 drilling hole locations. b. Drill holes with a driller, and make sure the holes are deep enough (at least 60 mm).
 	
Step 3&4	a. Place sleeves in the holes, and then tighten them. b. Fix the wall bracket with expansion screws. Please confirm that the bracket is firmly attached to the mounting surface.
 	
Step 5&6	a. Mount the inverter on the bracket. b. Tighten the screw with a torque of 1.4 N·m to secure the bracket and the inverter.
 	

7 Electrical Connection

⚠ WARNING

Before any electrical connections, keep in mind that the inverter has dual power supplies. It is mandatory for the qualified personnel to wear personal protective equipment (PPE) during electrical work.

NOTICE

Before connecting the cables, use the adjustable wrench to unscrew the waterproof plugs with a torque of at least 7 N·m. The size of the adjustable wrench can be adjusted to 41 mm (1.61 in) and 32 mm (1.26 in) according to the size of the waterproof plugs.

7.1 Overcurrent Protection Requirement

To ensure safe connection and operation, it is recommended to install an overcurrent protection device (circuit breaker) while installing PV cables, battery cables, grid cables, EPS cables, and GEN cables. The following data is the recommended specification for the overcurrent protection device.

Overcurrent Protection (Circuit Breaker)	Recommended Specification	Recommended Cable Range (90°C/194°F, Copper)
	11.5LV	11.5LV
PV	20 A	14-6 AWG
Battery	250 A	4/0 AWG
Grid L1/L2	100 A	3-1 AWG
EPS/GEN L1/L2	50 A	8-6 AWG

ⓘ NOTE

- Select the appropriate circuit breaker according to the actual installation.
- The overcurrent protection device (circuit breaker) is not provided by TuroGize and should be prepared separately.

7.2 Recommended Cable List

The following table provides the cable specifications recommended by TuroGize, based on the maximum current for PV, battery, GRID, EPS, GEN, and communication ports.

For proper cable specifications, please refer to local laws and regulations and actual installation.

Cable (90°C/194°F, Copper)	Recommended Specification	Stripping Length
	11.5LV	11.5LV
PV Cable	12 AWG	14 mm/0.55 in
Battery Cable	4/0 AWG	23 mm/0.91 in
Battery Ground Cable	6 AWG	12 mm/0.47 in
Grid L1/L2 Cable	3 AWG	24 mm/0.94 in
Grid N Cable	3 AWG (Recommended to be 8 AWG)	18 mm/0.71 in
Grid Ground Cable	8 AWG	12 mm/0.47 in
EPS/GEN L1/L2/N Cable	8 AWG	18 mm/0.71 in
EPS/GEN Ground Cable	8 AWG	12 mm/0.47 in
Communication Cable	24 AWG	8 mm/0.31 in

7.3 Opening the Wiring Box Cover

Procedure	
Step 1	Loosen but do not remove the 6 screws of the wiring box cover with T20 screwdriver.
Step 2	Remove the cover.

7.4 PV Cable Connection

⚠ WARNING

Before connecting PV cables, please make sure all requirements listed below are followed.

- The voltage, current and power ratings of the panels to be connected are within the allowable range of the inverter. Ensure the polarity is correct, and please refer to the technical parameters in [12 Technical Datasheet](#) for voltage and current limits.
- If the PV cables are reversely connected or if the inverter is not working properly, do not turn off the DC switch. Otherwise, it may cause a DC arc, fire, or damage to the inverter. After the PV input current drops below 0.5 A, disconnect the DC switch and adjust the polarity of the PV strings.
- Since the inverter is a transformerless structure, please do not ground the outputs of PV panels.
- Check the cable connection of the PV strings for correct polarity, and ensure that, in any case, the open-circuit voltage does not exceed the inverter input limit of 550 V.

Overcurrent Protection (Circuit Breaker)	Recommended Specification	Recommended Cable Range (90°C/194°F, Copper)
		TGP-INV-HY-LV-11.5
PV	20 A	14-6 AWG

Cable (90°C/194°F, Copper)	Recommended Specification	Stripping Length
		TGP-INV-HY-LV-11.5
PV Cable	12 AWG	14 mm/0.55 in

Procedure	
Step 1	Strip the cable insulation by 14 mm (0.55 in).
Step 2	Insert the PV cables into the terminals, and gently pull the cables backward to ensure that they are firmly connected.

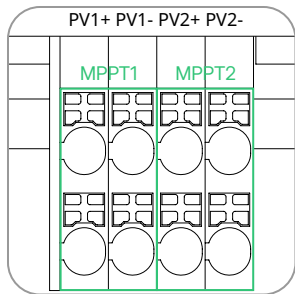
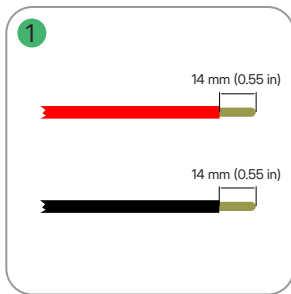
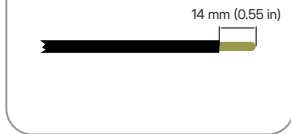
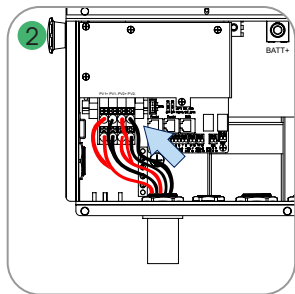
7.5 Battery Cable Connection

This section mainly describes the cable connections on the inverter side. Refer to the instructions supplied by the battery manufacturer for the connections on the battery side.

For batteries without a built-in DC breaker, make sure that an external DC breaker is connected.

If you need to use this hybrid inverter or AC-coupled inverter as a grid-tied inverter, please contact TuroGize.

⚠ WARNING

- A two-pole DC breaker with an overcurrent protection (OCP) function is compulsory to be installed between the inverter and battery. The battery may have this switch integrated. If not, an external DC switch of proper ratings should be used.
- Make sure the breaker mentioned above is in the "OFF" position.
- Check the cable connection of the battery for correct polarity, and ensure that, in any case, the open-circuit voltage does not exceed the inverter input limit of 60 V.
- Before proceeding to the next step, make sure that the battery voltage is 0 Vdc through a multimeter.

NOTICE

- Do not turn on the battery switch until all cables are properly connected.
- The inverter supports both Li-ion and lead-acid batteries. Only qualified personnel can install, operate, and maintain the inverter and the battery.
- Please refer to <https://www.TuroGize.com> for the compatible Li-ion battery list.
- For detailed battery settings, refer to [9 TGPower Cloud](#).

Overcurrent Protection (Circuit Breaker)	Recommended Specification	Recommended Cable Range (90°C/194°F, Copper)
		11.5LV
Battery	250 A	4/0 AWG

Cable (90°C/194°F, Copper)	Recommended Specification	Stripping Length
		11.5LV
Battery Cable	4/0 AWG	23 mm/0.91 in
Battery Ground Cable	6 AWG	12 mm/0.47 in

Procedure	
Step 1	a. Strip the battery cable insulation by 23 mm (0.91 in). b. Strip the battery ground cable insulation by 12 mm (0.47 in).
Step 2	Firstly, use the slotted screwdriver to unscrew the screw on the grounding bar, insert the battery ground cable, and tighten the screw. Secondly, use the hex wrench to unscrew the bolts, insert the battery cables into the terminals, and then tighten the bolts. Gently pull the battery cables and battery ground cable backward to ensure that they are firmly connected.

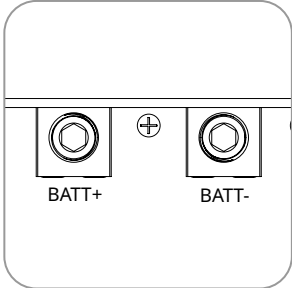
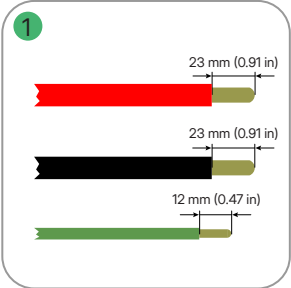
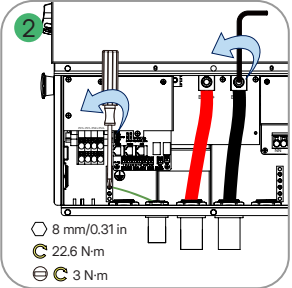
7.6 AC Cable Connection

The following diagrams are examples of connecting grid cables, and the GEN and EPS connection methods are the same as grid connection. For recommended cable specifications, please refer to the following recommended cable list.

⚠ WARNING

Before connecting the AC cables, please make sure all requirements listed below are followed.

- An independent two or three circuit breaker must be installed on the output side of the inverter to ensure safe disconnection from the grid.
- Multiple inverters cannot share one circuit breaker.
- Never connect a load between the inverter and the circuit breaker.
- Ensure that the overcurrent protection devices (OCPDs) (breakers) are turned off.
- Ensure the rated power of the EPS load does not exceed the rated output power of the inverter.
- Ensure that the starting power of inductive loads, such as air conditioners, refrigerators, and pumps, does not exceed the EPS peak power of the inverter. (The starting power of the air conditioner is at least 2 times the rated power. For details, refer to the appliance manual.) Otherwise, the inverter will stop output or even shut down with a fault alarm.

Before proceeding to the next step, make sure that the AC voltages are 0 Vac through a multimeter.

Overcurrent Protection (Circuit Breaker)	Recommended Specification	Recommended Cable Range (90°C/194°F, Copper)
		11.5LV
Grid L1/L2	100 A	3-1 AWG
EPS/GEN L1/L2	50 A	8-6 AWG

Cable (90°C/194°F, Copper)	Recommended Specification	Stripping Length
		11.5LV
Grid L1/L2 Cable	3 AWG	24 mm/0.94 in
Grid N Cable	8 AWG	18 mm/0.71 in

Cable (90°C/194°F, Copper)	Recommended Specification	Stripping Length
		11.5LV
Grid Ground Cable	8 AWG	12 mm/0.47 in
EPS/GEN L1/L2/N Cable	8 AWG	18 mm/0.71 in
EPS/GEN Ground Cable	8 AWG	12 mm/0.47 in

Procedure	
Step 1	a. Strip the grid L1/L2 cable insulation by 24 mm (0.94 in), and strip the grid N cable insulation by 18 mm (0.71 in). b. Strip the grid ground cable insulation by 12 mm (0.47 in).
Step 2	Firstly, use the slotted screwdriver to unscrew the screw on the grounding bar, insert the grid ground cable, and tighten the screw. Secondly, insert the L1/L2/N into the grid terminals. Gently pull the grid cable and grid ground cable backward to ensure that they are firmly connected.

7.6.1 GEN Port Limit

If the GEN port is connected to the PV inverter or generator, the GEN port limits are described as follows:

Inverter Model	11.5LV
Rated input voltage of GEN port	240 V
Max. input current of GEN port	40 A
Recommended AC breaker	50 A/240 V
Recommended cable	8-6 AWG

- Select the appropriate AC breaker in accordance with local laws and regulations.
- The grid-connected PV inverter connected to the GEN port must have an overfrequency protection function.

7.6.2 Generator Control

A generator can be connected to the GRID port or GEN port, and multiple generators only can be connected to the GRID port. It is recommended to use generators controlled by dry contact. Connect the generator to the DO1 port of the inverter as described in [7.7.3 DO Connection](#), and start and stop it using the TGPower App. For detailed online operations, please refer to [9.3.4 Set Dry Contact Function](#).

7.6.3 Heat Pump Control

A heat pump can be connected to the GRID port. Meanwhile, connect it to the DO1 port of the inverter as described in [7.7.3 DO Connection](#), and start and stop it using the TGPower App. For detailed online operations, please refer to [9.3.4 Set Dry Contact Function](#).

7.7 Communication Cable Connection

Detailed pin functions of each port on the communication interface are as follows.

NOTE

The wiring sequence of the network cable for parallel terminals differs from that of a standard network cable. For details, see the figure below.

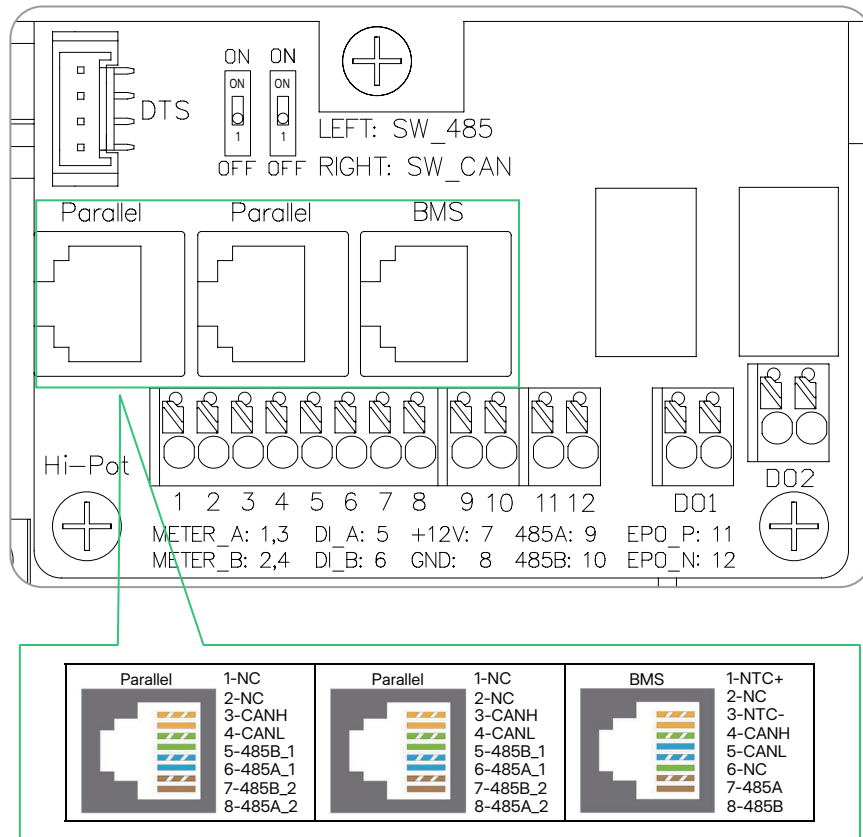

Label	Description
Parallel (CANH, CANL, 485B_1, 485A_1, 485B_2, 485A_2)	For parallel operation.
BMS (NTC+, NTC-, CANH, CANL, 485A, 485B)	For Li-ion batteries, communication is via CAN. For lead-acid batteries, the temperature is monitored via a sensor through NTC+ and NTC-.
SW_485 (ON, OFF)	120 Ohm termination resistor for parallel operation.
SW_CAN (ON, OFF)	120 Ohm termination resistor for parallel operation.

Meter (485A1, 485B1, 485A2, 485B2)	For the smart meter. One is connected to the grid side, and the other is connected to the third-party inverter.
DI (DI_A, DI_B)	Dry contact input of external bypass contactor.
+12V/GND	Reserved.
EPO_P/EPO_N	For external Emergency Power Off switch.
DO1 (NO1, COM1)	Dry contact output. The DO1 can be set to one of the functions as follows: Earth Fault Alarm, Load Control, and Generator Control.
DO2 (NO2, COM2)	Dry contact output. The DO2 will control the bypass contactor under certain logic.

7.7.1 Smart Meter and CT Connection

The smart meter and CT in the accessory box are necessary for system installation and are used to provide the operating condition of the inverter via RS485 communication.

WARNING

Before connecting the smart meter and CT, ensure that the AC cable is totally isolated from the AC power source.

NOTICE

- One smart meter can be used with only one inverter.
- One CT must be used for one smart meter and must be connected to the same phase with the smart meter power cable.
- There is a symbol (arrow) or label on the surface of CT that indicates the correct mechanical orientation of the CT on the conductor under measurement. Please identify the arrow or label before installing the CT.
- The communication cable should be a standard minimum 24 AWG 2 conductor wire.

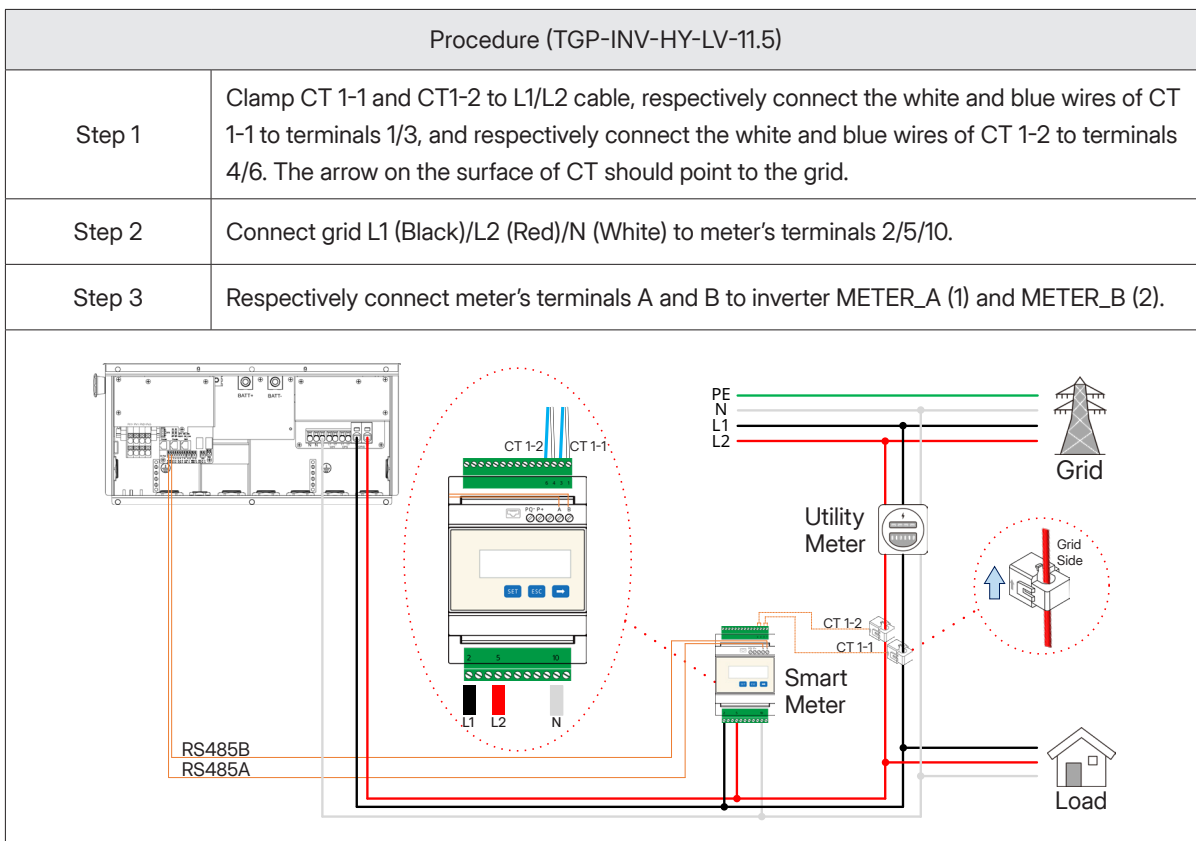

NOTICE

- Make sure grid power meter is set to **address 002**.

Below are the key sequences to reprogram the meter. Follow through until you get to **Address** and change from **001** to **002**. If the Addr has already been set to 2, then do not change it (don't press arrow).

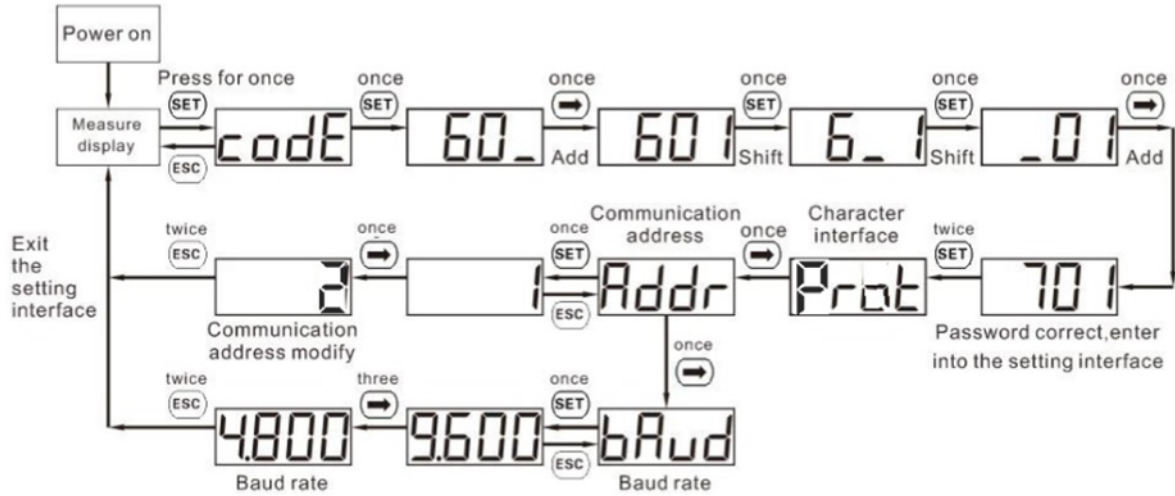

Setting examples for communication address and Baud Rate

When input digits, “SET” can be used as cursor “_” motion button; “→” is “add” button, “ESC” is Exit the programming operation interface or switch to the character interface from digit modification interface, add from the beginning after setting the digit to the maximum value.

NOTE

- If needed, the smart meter must be purchased from TuroGize.
- If the PV inverter is connected to the GEN port, there is no need to install smart meter (PV INV).
- If there are meter communication problems, please check if the address of the PV inverter side meter is set to 001, and the address of the grid side meter is set to 002.

7.7.2 DI Connection

There is an integrated DI (DLA, DLB) as the dry contact input to the bypass contactor of the inverter.

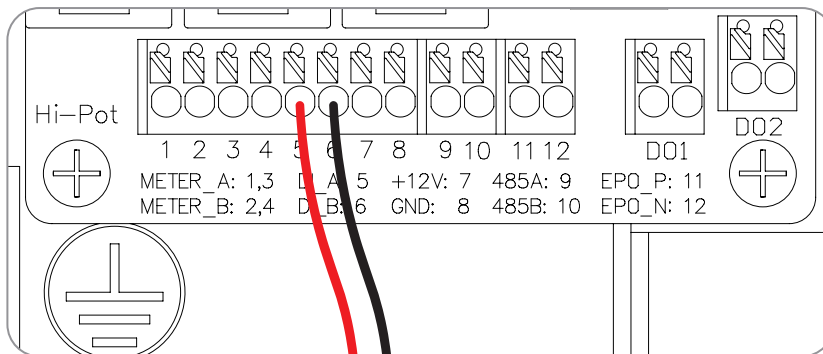

7.7.3 DO Connection

The inverter has integrated a multiple-function dry contact (DO1 and DO2). The DO1 can be set to one of the functions as follows, Earth Fault Alarm, Load Control, and Generator Control. The DO2 can control the external bypass contactor if installed.

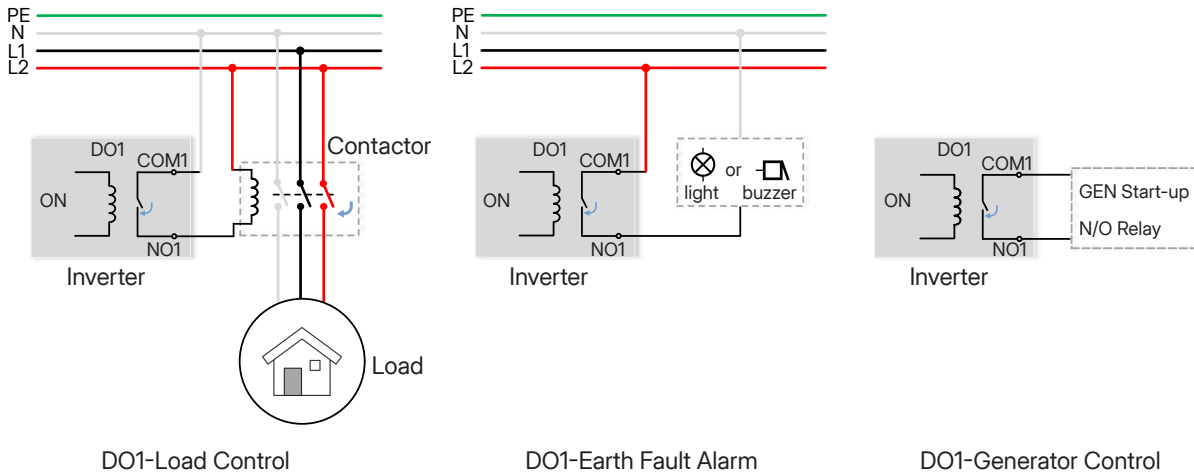
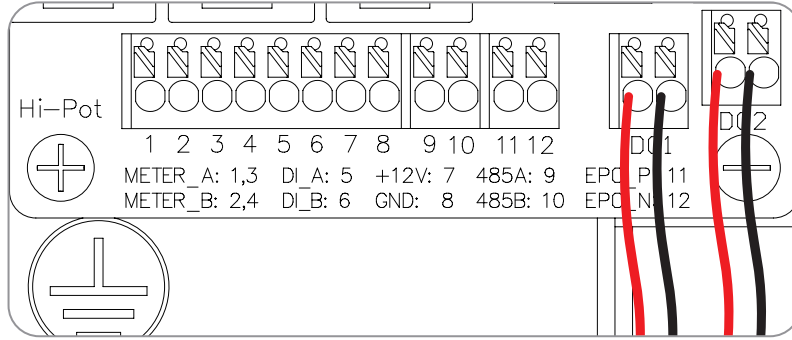

7.7.4 BMS Connection

BMS is used to communicate with compatible Li-ion batteries. Note that the communication cable should be a standard CAT 5 Ethernet cable.

If a lead-acid battery is used to work with this inverter, the battery temperature sensor in the packing list shall be used to monitor the battery temperature.

Procedure	
Step 1	Strip the communication cable insulation with an Ethernet wire stripper, and lead the corresponding signal cables out. Insert the signal cables into the RJ45 plug in the correct order, and crimp it with a network cable crimper.
Step 2	Insert the RJ45 plug into the BMS port, and gently pull the cable backward to make sure that the plug is completely connected to the BMS port. The pin definition of BMS or battery temperature sensor is shown as follows.

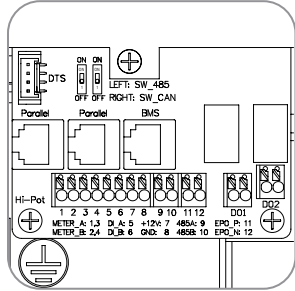
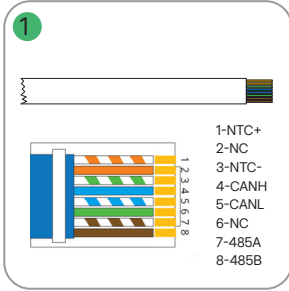
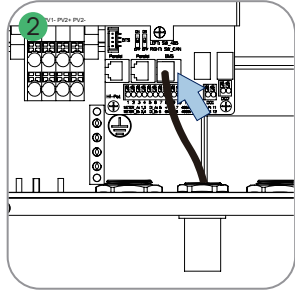
7.8 Parallel Connection

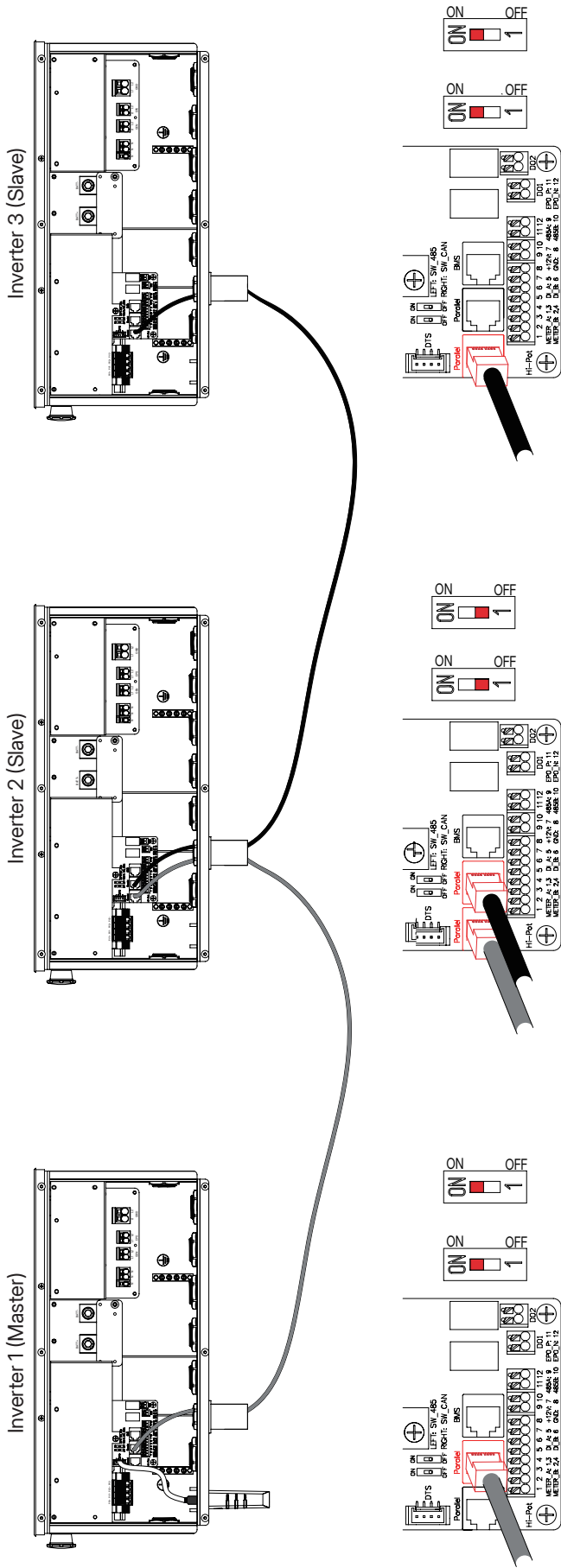

NOTE

- As shown in the figure, parallel operation is performed through the parallel interface. When inverters are used in parallel, the first and the last inverters are "ON", and the others are "OFF".
- Ensure that the total length of the cables used for parallel communication does not exceed 20 m. (66 ft).

7.8.1 Parallel System 1

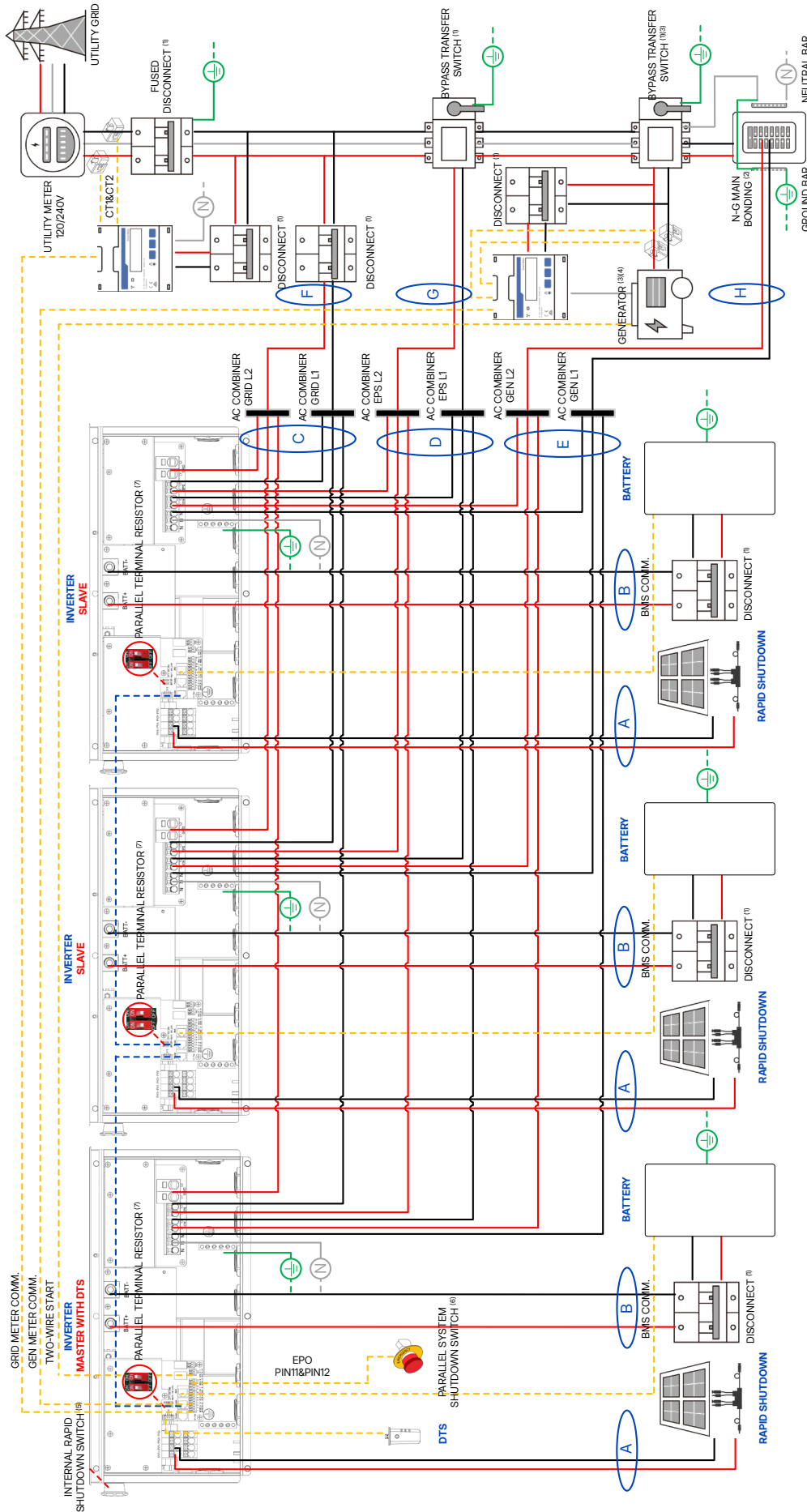

LINE DIAGRAM FOR PARALLEL INVERTERS | 120 / 240 V
 SCENARIO 1-1: DC COUPLING SYSTEM AND WHOLE HOME BACKUP WITH GENERATOR
 THE NUMBER OF INVERTERS: MAX:10
 BATTERY CAPACITY OF THE SYSTEM: MAX:80 kWh

(6) EMERGENCY POWER OFF SWITCH FOR PARALLEL SYSTEM ACCORDING TO THE NEC CODE:

Switch Type	Contact Type	System Energized	System Shutdown
Rotary Switch	Short in ON position	ON position	OFF position
Plunger Type (Mushroom)	NIC (Normally Closed) Short released	Released	Pressed

(7) BASED ON THE NUMBER OF INVERTERS IN THE SYSTEM, SET THE TERMINAL RESISTORS ACCORDING TO THE FOLLOWING REQUIREMENTS.

(1) SIZE OF DISCONNECT / BYPASS SWITCH WILL DEPEND ON REQUIRED PASSTHROUGH CURRENT AND LOCAL CODE REQUIREMENTS.
 (2) LOCATION OF THE NEUTRAL-GROUND MAIN BONDING WILL DEPEND ON LOCAL CODE.
 (3) AUTOMATIC TRANSFER SWITCH IS RECOMMENDED. GENERATOR MUST BE CONNECTED TO ATIS SOURCE (NORMAL), SO THAT ATIS WILL AUTOMATICALLY TRANSFER TO SOURCE 1 WHEN BOTH SOURCE 1 AND SOURCE 2 HAVE POWER SUPPLIES.
 (4) A TWO-WIRE AUTO-START GENERATOR IS RECOMMENDED.
 (5) MAKE SURE THAT INTERNAL RAPID SHUTDOWN SWITCH IS IN 'ON' POSITION.



Cable (90°C/194°F, Copper)	Recommended Cable Specification	
A (PV)	TGP-INV-HY-LV-11.5 14 AWG-6 AWG	
B (Battery)	4/0 AWG	
C (Grid)	4 AWG-1 AWG	
D/E (EPS/GEN)	8 AWG-6 AWG	
F (Coupling on Grid Side)	TGP-INV-HY-LV-11.5	
	#3 AWG	
	TGP-INV-HY-LV-11.5*2	
	3/0 AWG	
	TGP-INV-HY-LV-11.5*3	
	300 AWG	
	TGP-INV-HY-LV-11.5*4	
	500 AWG	
	TGP-INV-HY-LV-11.5*5	
	700 AWG	
	TGP-INV-HY-LV-11.5*6	
	1000 AWG	
	TGP-INV-HY-LV-11.5*7	
	1500 AWG	
	TGP-INV-HY-LV-11.5*8	
	2*500 AWG	
	G/H (Coupling on EPS/GEN Side)	TGP-INV-HY-LV-11.5*9
		2*600 AWG
TGP-INV-HY-LV-11.5*10		
2*700 AWG		
TGP-INV-HY-LV-11.5		
#8 AWG		
TGP-INV-HY-LV-11.5*2		
#3 AWG		
TGP-INV-HY-LV-11.5*3		
1/0 AWG		
TGP-INV-HY-LV-11.5*4		
3/0 AWG		
TGP-INV-HY-LV-11.5*5		
4/0 AWG		
TGP-INV-HY-LV-11.5*6		
300 AWG		
TGP-INV-HY-LV-11.5*7		
350 AWG		
TGP-INV-HY-LV-11.5*8		
500 AWG		
TGP-INV-HY-LV-11.5*9		
600 AWG		
TGP-INV-HY-LV-11.5*10		
700 AWG		

Cable (90°C/194°F, Copper)	Overcurrent Protection Parameter
A (PV)	TGP-INV-HY-LV-11.5 20 A
B (Battery)	250 A
C (Grid)	100 A
D/E (EPS/GEN)	50 A
F (Coupling on Grid Side)	TGP-INV-HY-LV-11.5
	100 A
	TGP-INV-HY-LV-11.5*2
	200 A
	TGP-INV-HY-LV-11.5*3
	300 A
	TGP-INV-HY-LV-11.5*4
	400 A
	TGP-INV-HY-LV-11.5*5
	500 A
	TGP-INV-HY-LV-11.5*6
	600 A
	TGP-INV-HY-LV-11.5*7
	700 A
	TGP-INV-HY-LV-11.5*8
	800 A
TGP-INV-HY-LV-11.5*9	
900 A	
TGP-INV-HY-LV-11.5*10	
1000 A	
G/H (Coupling on EPS/GEN Side)	TGP-INV-HY-LV-11.5
	50 A
	TGP-INV-HY-LV-11.5*2
	100 A
	TGP-INV-HY-LV-11.5*3
	150 A
	TGP-INV-HY-LV-11.5*4
	200 A
	TGP-INV-HY-LV-11.5*5
	250 A
	TGP-INV-HY-LV-11.5*6
	300 A
	TGP-INV-HY-LV-11.5*7
	350 A
	TGP-INV-HY-LV-11.5*8
	400 A
TGP-INV-HY-LV-11.5*9	
450 A	
TGP-INV-HY-LV-11.5*10	
500 A	

7.8.2 Parallel System 2

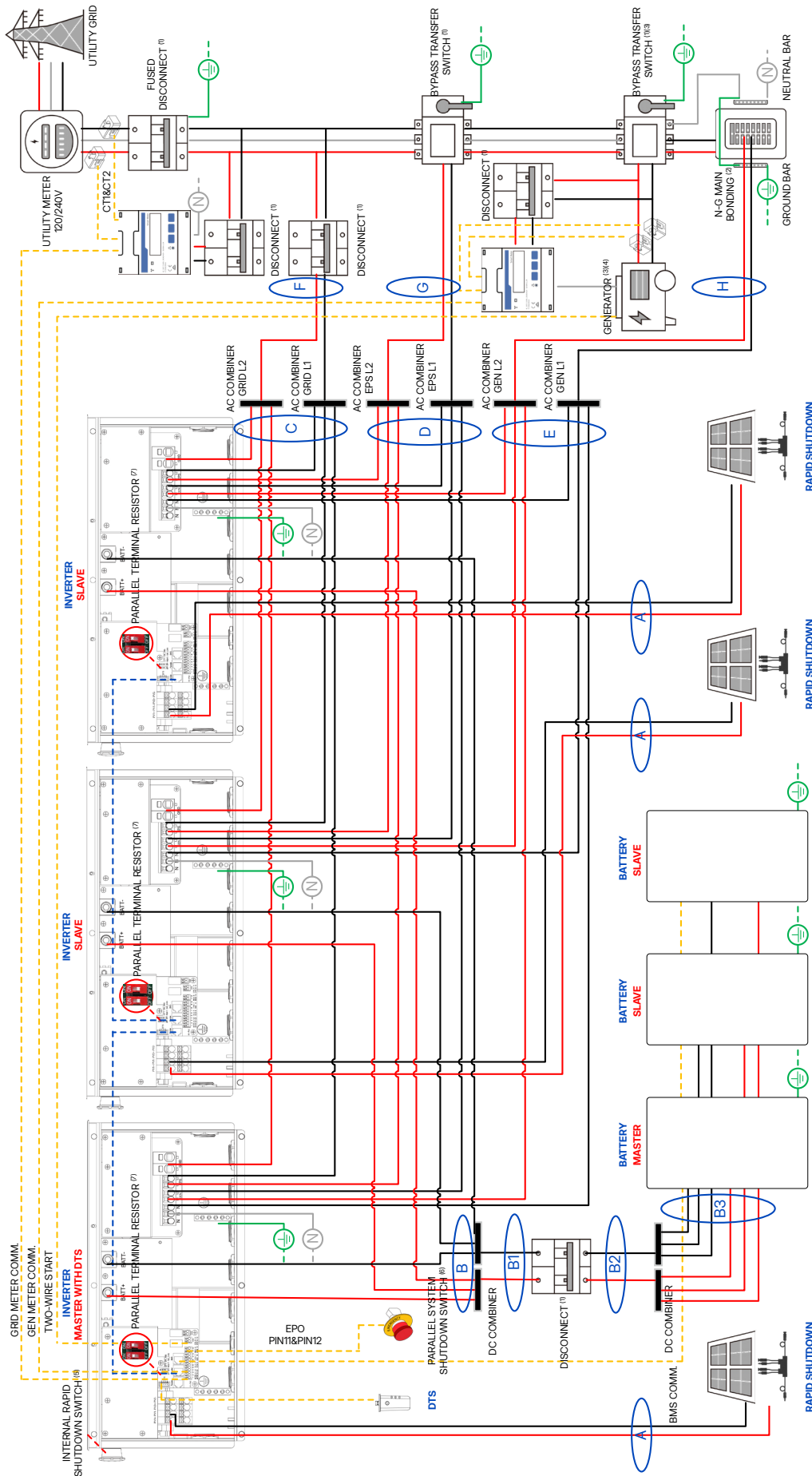

LINE DIAGRAM FOR PARALLEL INVERTERS | 120 / 240 V SCENARIO 1-2: DC COUPLING SYSTEM AND WHOLE HOME BACKUP WITH GENERATOR (BATTERIES ARE CONNECTED TO THE SAME BUSBAR) THE NUMBER OF INVERTERS: MAX.10 BATTERY CAPACITY OF THE SYSTEM: MAX.80KWh

LEGEND:

- DC - NEGATIVE: Solid black line
- AC - L1: Solid red line
- DC - POSITIVE: Dashed black line
- AC - L2: Dashed red line
- NEUTRAL: Solid green line
- GROUND: Solid blue line
- COMM: Dashed yellow line
- Parallel: Dashed blue line

NOTES:

- (1) SIZE OF DISCONNECT / BYPASS SWITCH WILL DEPEND ON REQUIRED PASSTHROUGH CURRENT AND LOCAL CODE REQUIREMENTS.
- (2) LOCATION OF THE NEUTRAL-GROUND MAIN BONDING WILL DEPEND ON LOCAL CODE.
- (3) AUTOMATIC TRANSFER SWITCH IS RECOMMENDED. GENERATOR MUST BE CONNECTED TO ATS SOURCE (NORMAL), SO THAT ATS WILL AUTOMATICALLY TRANSFER TO SOURCE 1 WHEN BOTH SOURCE 1 AND SOURCE 2 HAVE POWER SUPPLIES.
- (4) A TWO-WIRE AUTO-START GENERATOR IS RECOMMENDED.
- (5) MAKE SURE THAT INTERNAL RAPID SHUTDOWN SWITCH IS IN "ON" POSITION.

EMERGENCY POWER OFF SWITCH FOR PARALLEL SYSTEM ACCORDING TO THE NEC CODE:

Switch Type	Contact Type	System Energized	System Shutdown
Rotary Switch	Short in ON position	ON position	OFF position
Plunger Type (Mushroom)	NC (Normally Closed)	Released	Pressed
	Short released	Released	Pressed

OPERATION INSTRUCTIONS:

BASED ON THE NUMBER OF INVERTERS IN THE SYSTEM, SET THE TERMINAL RESISTORS ACCORDING TO THE FOLLOWING REQUIREMENTS.

- SET THE MASTER INVERTER TO **ON** AND THE SLAVE INVERTER TO **OFF**.
- SET THE SLAVE INVERTER TO **OFF** AND THE MASTER INVERTER TO **ON**.

INTERNAL RAPID SHUTDOWN SWITCH POSITION:

- SET THE SLAVE INVERTER TO **OFF** AND THE MASTER INVERTER TO **ON**.
- SET THE SLAVE INVERTER TO **OFF** AND THE MASTER INVERTER TO **OFF**.
- SET THE SLAVE INVERTER TO **ON** AND THE MASTER INVERTER TO **OFF**.
- SET THE SLAVE INVERTER TO **ON** AND THE MASTER INVERTER TO **ON**.

INTERNAL RAPID SHUTDOWN SWITCH POSITION:

- SET THE SLAVE INVERTER TO **OFF** AND THE MASTER INVERTER TO **ON**.
- SET THE SLAVE INVERTER TO **OFF** AND THE MASTER INVERTER TO **OFF**.
- SET THE SLAVE INVERTER TO **ON** AND THE MASTER INVERTER TO **OFF**.
- SET THE SLAVE INVERTER TO **ON** AND THE MASTER INVERTER TO **ON**.

TUROGIZE

Cable (90°C/194°F, Copper)	Recommended Cable Specification
A (PV)	TGP-INV-HY-LV-11.5 14 AWG-6 AWG
B (Inverter Side)	4/0 AWG
B1 (BAT Coupling)	Inverter Side. Depending on the model and quantity of parallel inverters.
B2 (BAT Coupling)	Battery Side. Depending on the model and quantity of parallel batteries. The cable capacity on the B1 side should be nearly identical to that on the B2 side.
B3 (Battery Side)	Depending on the model of the battery.
C (Grid)	4 AWG-1 AWG
D/E (EPS/GEN)	8 AWG-6 AWG
F (Coupling on Grid Side)	TGP-INV-HY-LV-11.5
	#3 AWG
	TGP-INV-HY-LV-11.5*2
	3/0 AWG
	TGP-INV-HY-LV-11.5*3
	300 AWG
	TGP-INV-HY-LV-11.5*4
	500 AWG
	TGP-INV-HY-LV-11.5*5
	700 AWG
	TGP-INV-HY-LV-11.5*6
	1000 AWG
	TGP-INV-HY-LV-11.5*7
	1500 AWG
	TGP-INV-HY-LV-11.5*8
	2*500 AWG
	TGP-INV-HY-LV-11.5*9
	2*600 AWG
	TGP-INV-HY-LV-11.5*10
	2*700 AWG
G/H (Coupling on EPS/GEN Side)	TGP-INV-HY-LV-11.5
	#8 AWG
	TGP-INV-HY-LV-11.5*2
	#3 AWG
	TGP-INV-HY-LV-11.5*3
	1/0 AWG
	TGP-INV-HY-LV-11.5*4
	3/0 AWG
	TGP-INV-HY-LV-11.5*5
	4/0 AWG
	TGP-INV-HY-LV-11.5*6
	300 AWG
	TGP-INV-HY-LV-11.5*7
	350 AWG
	TGP-INV-HY-LV-11.5*8
	500 AWG
TGP-INV-HY-LV-11.5*9	
600 AWG	
TGP-INV-HY-LV-11.5*10	
700 AWG	

Cable (90°C/194°F, Copper)	Overcurrent Protection Parameter
A (PV)	20 A
B (Battery)	250 A
C (Grid)	100 A
D/E (EPS/GEN)	50 A
F (Coupling on Grid Side)	TGP-INV-HY-LV-11.5
	100 A
	TGP-INV-HY-LV-11.5*2
	200 A
	TGP-INV-HY-LV-11.5*3
	300 A
	TGP-INV-HY-LV-11.5*4
	400 A
	TGP-INV-HY-LV-11.5*5
	500 A
	TGP-INV-HY-LV-11.5*6
	600 A
	TGP-INV-HY-LV-11.5*7
	700 A
	TGP-INV-HY-LV-11.5*8
	800 A
	TGP-INV-HY-LV-11.5*9
900 A	
TGP-INV-HY-LV-11.5*10	
1000 A	
G/H (Coupling on EPS/GEN Side)	TGP-INV-HY-LV-11.5
	50 A
	TGP-INV-HY-LV-11.5*2
	100 A
	TGP-INV-HY-LV-11.5*3
	150 A
	TGP-INV-HY-LV-11.5*4
	200 A
	TGP-INV-HY-LV-11.5*5
	250 A
	TGP-INV-HY-LV-11.5*6
	300 A
	TGP-INV-HY-LV-11.5*7
	350 A
	TGP-INV-HY-LV-11.5*8
	400 A
	TGP-INV-HY-LV-11.5*9
450 A	
TGP-INV-HY-LV-11.5*10	
500 A	

7.9 DTS Connection

7.9.1 TGP-ACC-DTS

NOTE

Choose the correct installation method based on the products you received.

If the adapter has been pre-installed on the inverter, tap [here](#).

Scenario One - The adapter hasn't been installed

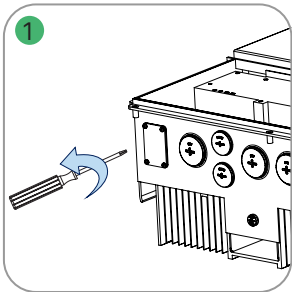
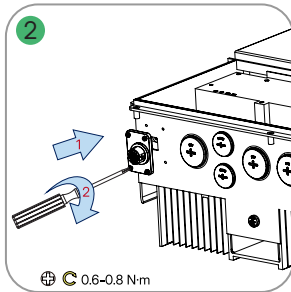
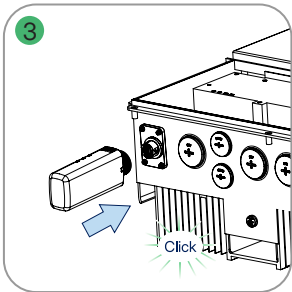
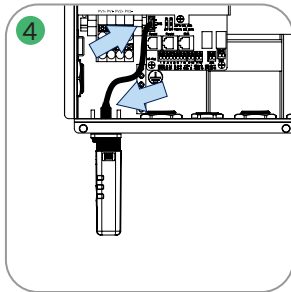
TGP-ACC-DTS	
Step 1	Remove the DTS port cover plate.
Step 2	Install the adapter.
<div style="display: flex; justify-content: space-around;"> <div style="text-align: center;">  <p>1</p> </div> <div style="text-align: center;">  <p>2</p> <p>0.6-0.8 Nm</p> </div> </div>	
Step 3	Insert the DTS into the terminal.
Step 4	Respectively connect the ends of the DTS connecting line to the corresponding ports.
<div style="display: flex; justify-content: space-around;"> <div style="text-align: center;">  <p>3</p> <p>Click</p> </div> <div style="text-align: center;">  <p>4</p> </div> </div>	

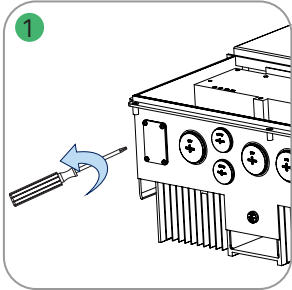
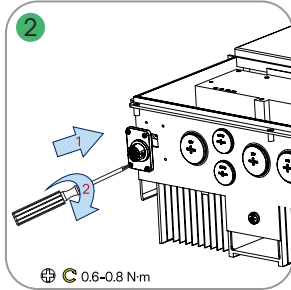
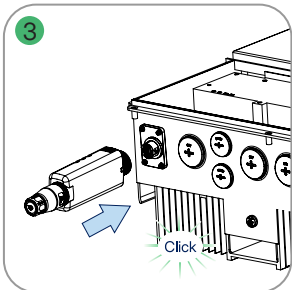
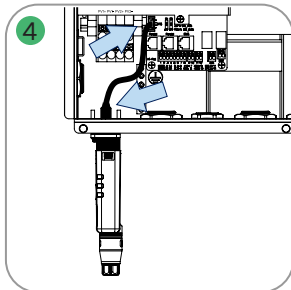
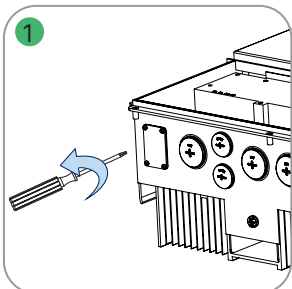
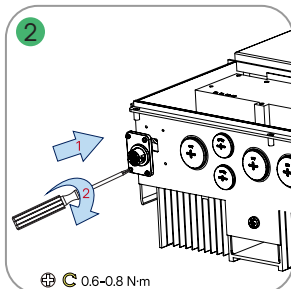
TGP-ACC-DTS (Wi-Fi Mode)	
Step 1	Remove the DTS port cover plate.
Step 2	Install the adapter.
<div style="display: flex; justify-content: space-around;"> <div style="text-align: center;">  <p>1</p> </div> <div style="text-align: center;">  <p>2</p> <p>⊕ 0.6-0.8 Nm</p> </div> </div>	
Step 3	Insert the DTS into the terminal.
Step 4	Respectively connect the ends of the DTS connecting line to the corresponding ports.
<div style="display: flex; justify-content: space-around;"> <div style="text-align: center;">  <p>3</p> <p>Click</p> </div> <div style="text-align: center;">  <p>4</p> </div> </div>	
TGP-ACC-DTS (LAN Mode)	
Step 1	Remove the DTS port cover plate.
Step 2	Install the adapter.
<div style="display: flex; justify-content: space-around;"> <div style="text-align: center;">  <p>1</p> </div> <div style="text-align: center;">  <p>2</p> <p>⊕ 0.6-0.8 Nm</p> </div> </div>	
Step 3	Disassemble the DTS in sequence.
Step 4	Thread the Ethernet cable through the parts and tighten them.

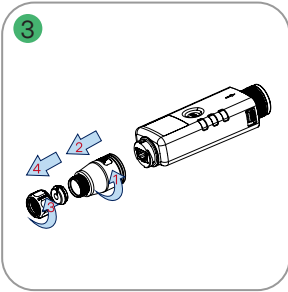
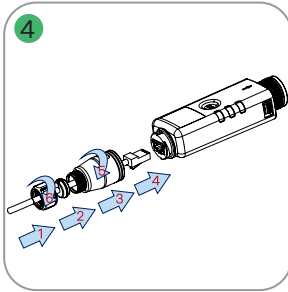
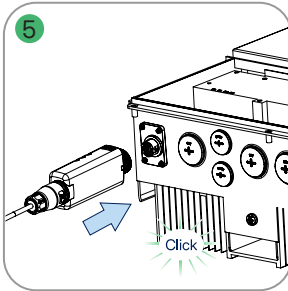
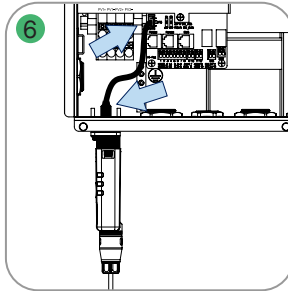
	
<p>Step 5</p>	<p>Insert the DTS into the terminal.</p>
<p>Step 6</p>	<p>Respectively connect the ends of the DTS connecting line to the corresponding ports.</p>
	

Scenario Two - The adapter has been pre-installed on the inverter

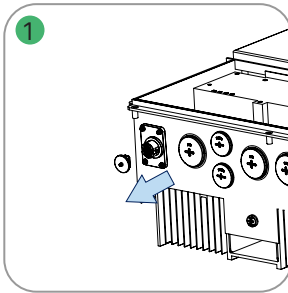
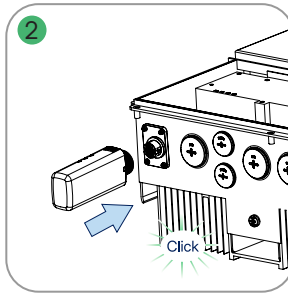
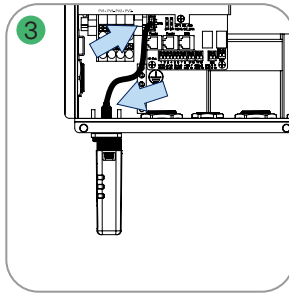
TGP-ACC-DTS		
<p>Step 1</p>	<p>Remove the cover of the adapter.</p>	
<p>Step 2</p>	<p>Insert the DTS into the terminal.</p>	
<p>Step 3</p>	<p>Respectively connect the ends of the DTS connecting line to the corresponding ports.</p>	
		

TGP-ACC-DTS (Wi-Fi Mode)	
Step 1	Remove the cover of the adapter.
Step 2	Insert the DTS into the terminal.
Step 3	Respectively connect the ends of the DTS connecting line to the corresponding ports.

NOTICE

- Record Serial number from DTS as it is required for commissioning with APP.

TGP-ACC-DTS (LAN Mode)	
Step 1	Disassemble the DTS in sequence.
Step 2	Thread the Ethernet cable through the parts and tighten them.
Step 3	Remove the cover of the adapter.
Step 4	Insert the DTS into the terminal.
Step 5	Respectively connect the ends of the DTS connecting line to the corresponding ports.

Indicator	Status	Description
NET	ON	The network is connected, and communication with the TGPower Cloud is normal.
	OFF	The network is not connected.
	BLINK	The network is connected, but communication with the TGPower Cloud is abnormal.
COM	ON	Communication with the inverter is normal.
	OFF	Communication with the inverter is abnormal.
RUN	ON	Connected to external power supply
	OFF	Not connected to external power supply
NET & COM	BLINK	Device Upgrading

7.10 Installing the Wiring Box Cover

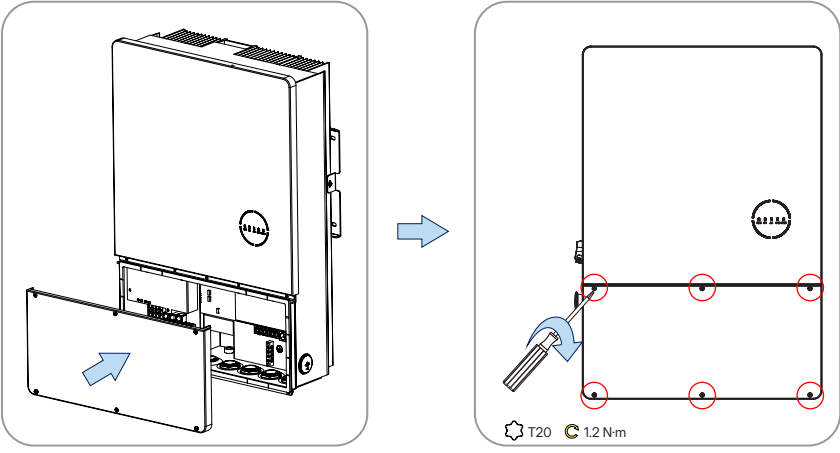
Procedure
After the wires are firmly and correctly connected, install the wiring box cover with a T20 screwdriver.

NOTE

To ensure the normal operation of the inverter with an IP65 rating, seal the cable inlet holes at the bottom of the inverter after it is successfully installed.

8 System Commissioning

8.1 Preparation

Before the commissioning of the inverter, make sure:

- The inverter DC switch and external circuit breaker are disconnected.
- The wiring follows the instructions in [7 Electrical Connection](#).
- The rapid shutdown switch is in the "ON" position.
- The grid voltage is within the permissible range through the multimeter before turning on the AC switch.
- Unused terminals must be sealed using corresponding sealing plugs.
- Nothing is left on the top of the inverter and battery.
- Cables are routed in a safe place or protected against mechanical damage.
- Warning signs and labels are intact.

8.2 System Power-on

Step 1 Turn on the battery power switch and DC breaker if the inverter is connected to the battery.

Step 2 Turn on the AC breaker between the inverter and the grid.

Step 3 Rotate the DC switch to "ON" if the inverter is connected to the PV strings.

Step 4 Verify that the inverter is operating properly by checking the [indicator status](#).

9 TGPower Cloud

The TGPower App has been developed for TuroGize and offers the following features.

- a. Network configuration
- b. Local installation assistant
- c. System setting and monitoring

Please download the TGPower App from the Google Play Store or the App Store.

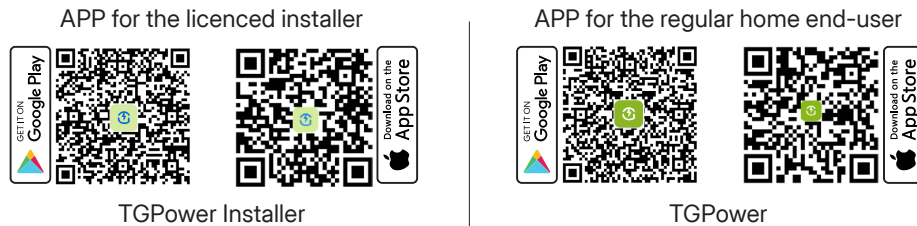

NOTICE: The **TGPower Installer APP** is for professional use only. Home end-users must exclusively use the **TGPower APP**; any unauthorized access or modification of settings via the Installer APP may **void your product warranty**.

NOTE

- **The DTU mentioned in this manual refers to the DTS (Data Transfer Stick).**
- In a residential energy storage system, the DTU displayed in the TGPower Cloud refers to the DTS (Data Transfer Stick).
- The screenshots shown in this manual are for reference only. Since the App version will be updated periodically, the interface displayed on your screen may differ.

9.1 Connect to the DTS

NOTE

- The steps about the password are only required for the first connection.

★ **TGP-ACC-DTS**

Step 1 Tap **O&M** > **Toolkit**.

Step 2 On the **Via Bluetooth** part, tap the **DTS** to be connected.

Step 3 Enter the default password **123456** and tap **Confirm**.

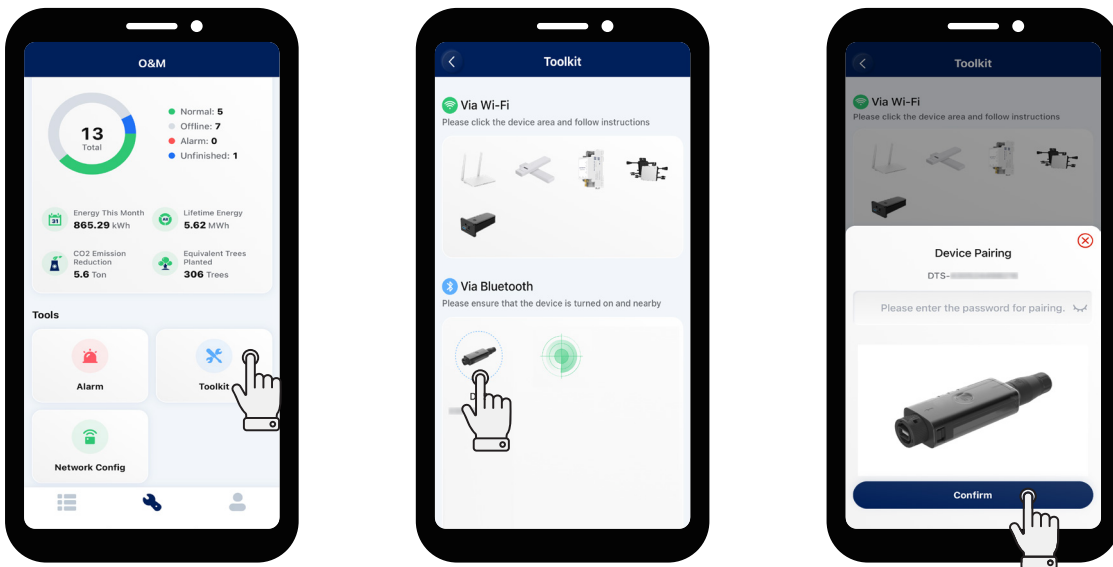

Step 4 Tap **Go to Settings** to change the default password.

Step 5 Enter the original password and new password, confirm the new one, and tap **Send to DTU**.

Attention: Please make sure end-user KEEP the new password after this setting.

This password will always be required in future network settings and new configurations.

Step 6 Tap **Toolkit** again.

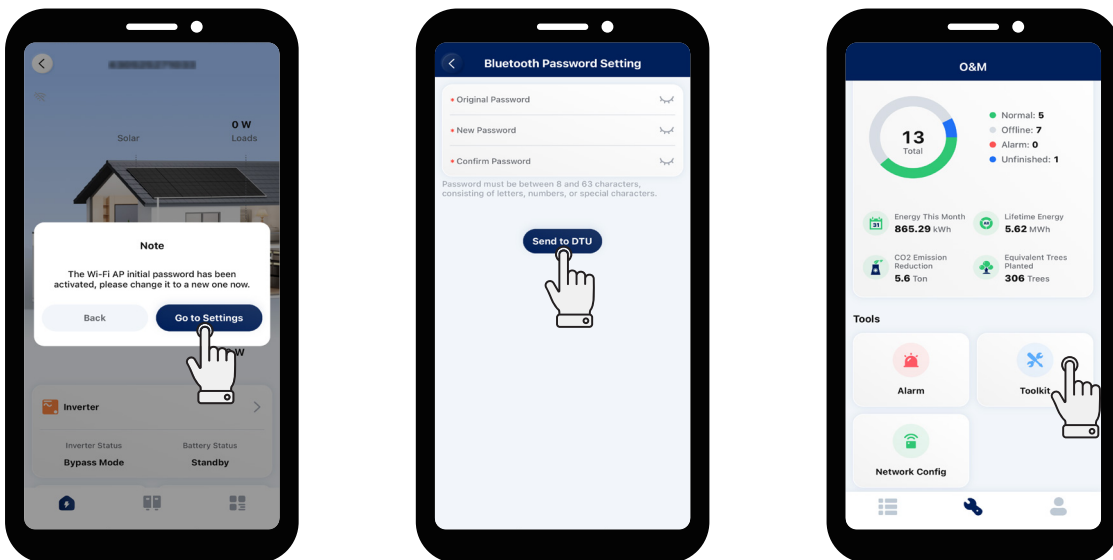

Step 7 On the **Via Bluetooth** part, tap the **DTS** to be connected.

Step 8 Enter the new password and tap **Confirm**.

NOTE

- Bluetooth connectivity may require you to Turn Off Bluetooth and Turn Bluetooth back on. Also avoid having multiple devices with Bluetooth turned on in close proximity.

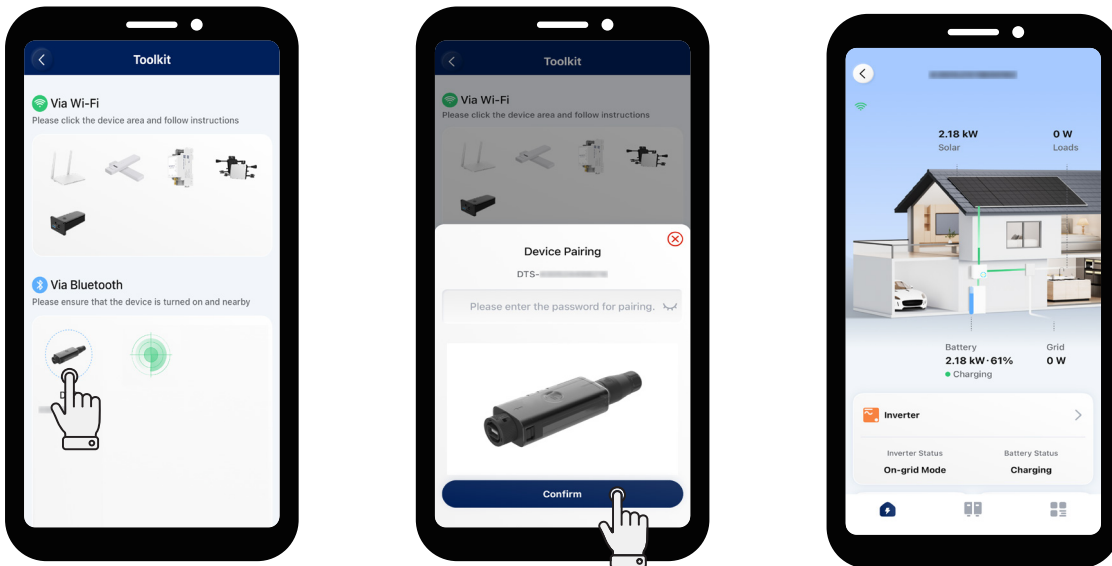

9.2 Start Commissioning

Commissioning is used to set and test a new residential energy storage system. It is a critical step to ensure that a new device and system can function properly according to the design specifications.

Step 1 Tap **O&M** > **Toolkit**.

Step 2 Tap **Commissioning**.

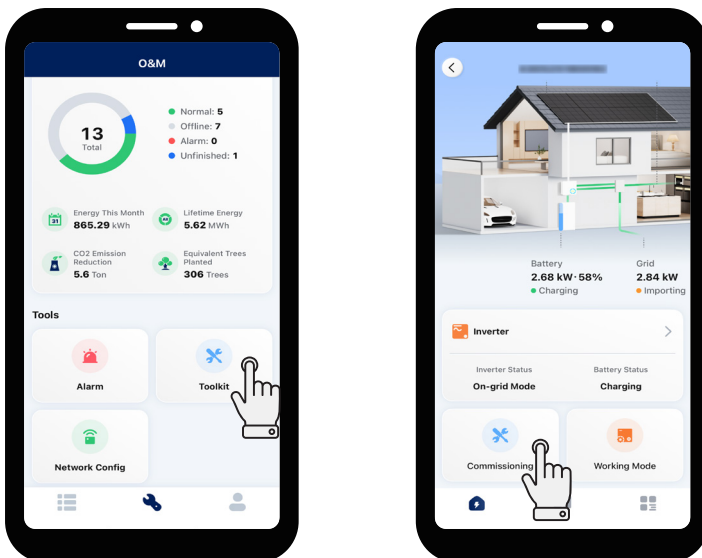

Step 3 Add devices

Follow the instructions below to add devices according to the actual installation, and tap **Next**.

- If a parallel system is installed, tap **Paralleling**. All slave inverters will be automatically added.

NOTE

- The DTS must be connected to the Master.
- After the slaves are connected to the Master through communication cables, they can communicate with the DTS.
- A DTS can only communicate with up to 10 inverters.



NOTE

To change the Master or use a single inverter, first tap > **Parallel** > **Unbind**. Otherwise, a communication fault will occur.

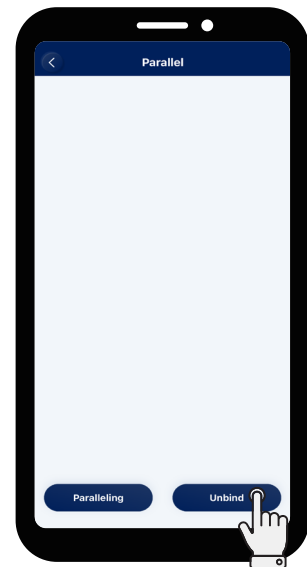
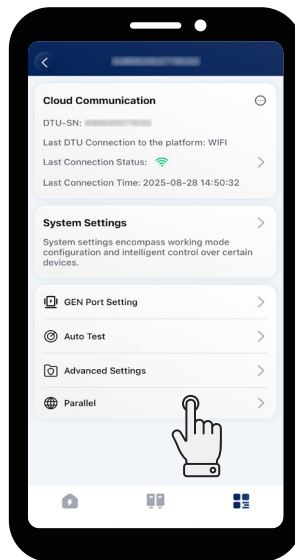
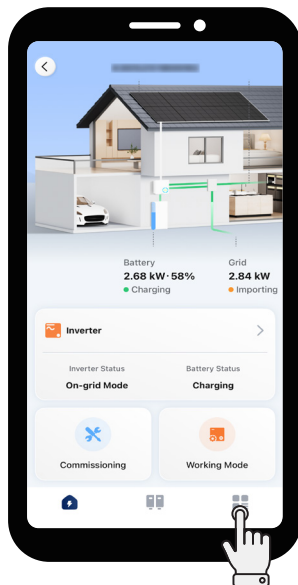

- If batteries are connected to the inverter, tap **Battery** to set battery parameters, and tap **Save**. Select TuroGize from the battery list.

NOTE

If Li-ion batteries are connected in parallel via the busbar, and the master battery communicates with the master inverter, enable **Multiple PCS**.

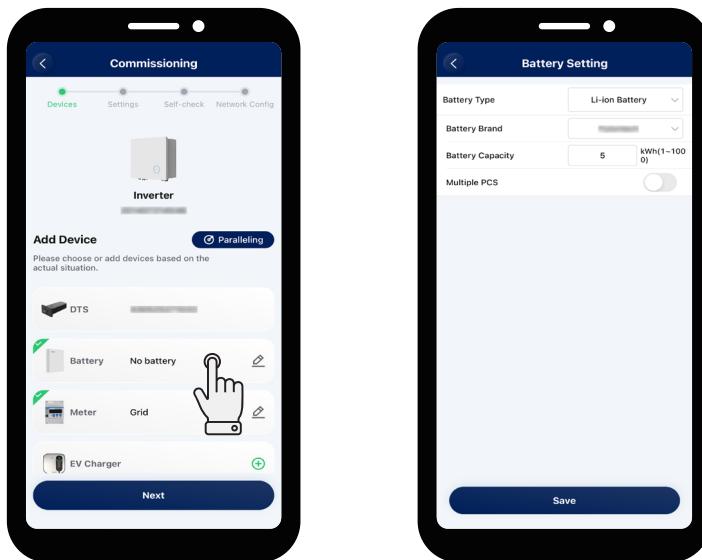

- Tap **Meter** and toggle on **Meter Settings**. Select the meter location based on the actual installation, and tap **Save**.

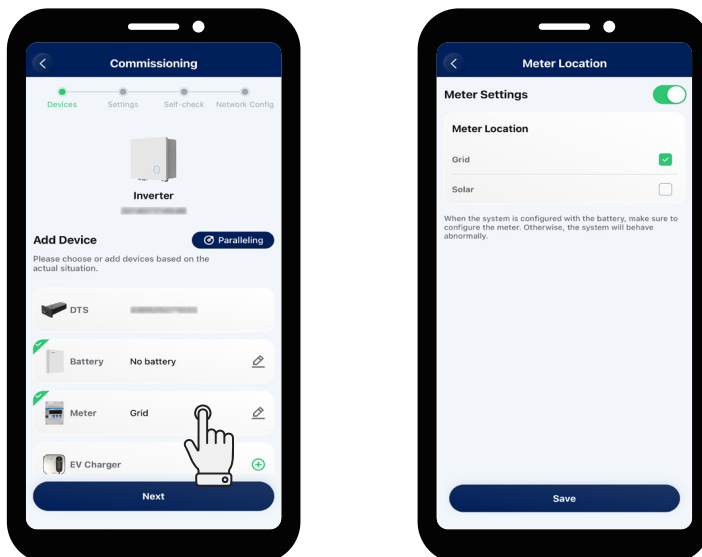

Step 4 Complete other settings

- Select the grid profile in your region, and tap **Next**.
- Select the working mode according to your actual needs, and tap **Next**. For details about working modes, refer to [9.3.3 Set Working Mode](#).
- Select **Generator** or **Inverter** according to the actual installation, and tap **Next**. (The default option is **None**.)

NOTE

If a generator is connected to the GEN port, detailed parameters are shown in [9.3.1 Set Advanced Parameters](#). After setting the parameters, tap [System Settings > Dry Contact Settings > Generator Control](#) to set its mode and corresponding parameters.

NOTE

- For Canada the grid profile for 240V is US_IEEE1547 and for 208V is IEEE1547_208V.
- Advanced settings should not be changed unless the power company tell you to.
- In case of an error popping out, it's recommended to: (1) switch another profile (2) switch back to the correct profile, it will be automatically reloaded with the latest version.
- If still not working, it's recommended to (1) upgrade firmware of inverter, (2) repeat the procedure above.

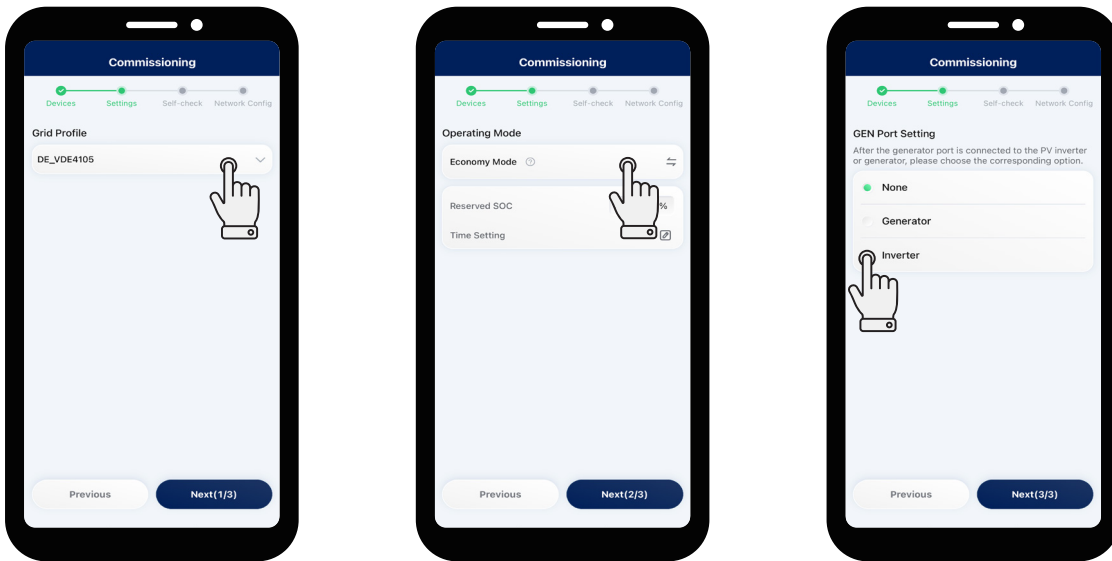

Step 5 Complete the self-check

You can complete or skip the self-check as required.

- If you want to complete the self-check, tap **Start Testing**. (**Highly** recommend **DO NOT** skip this step)

NOTE

- Before this operation, make sure that all cables including DC cables, AC cables, and communication cables, are properly connected, and all AC and DC switches are turned on.
- If the result shows the CT is reversely connected, tap **Advanced Settings > Grid CT reverse > Enable** or **PV CT reverse > Enable**, and tap **Save**. For details, refer to [9.31 Set Advanced Parameters](#).
- The self-check result is accurate only when the system is connected to the grid.

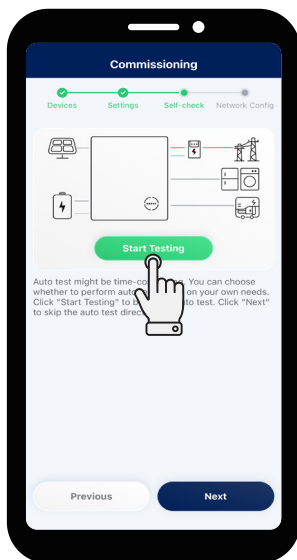

- If you want to skip this step, tap **Next > Confirm**.

NOTE

- It is strongly recommended to not skip this step.

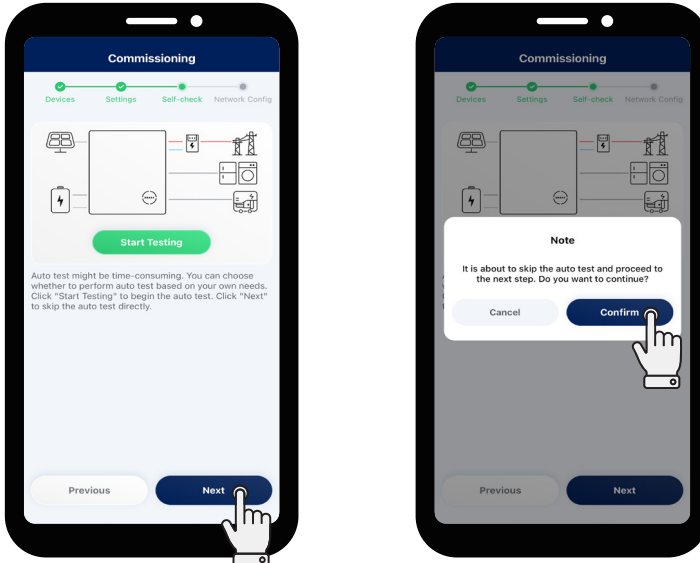

Step 6 Configure the network

NOTE

- **Go to Settings** will navigate to the new plant creation interface (haven't created a plant before the commissioning) or the homepage of the plant (have created a plant before the commissioning).
- For DTS-G1, after completing the commissioning, if you want to tap **Go to Settings**, first disconnect from the DTU Wi-Fi.

- **Wi-Fi Mode**
 - Select **Wi-Fi**, enter or select the Wi-Fi network name, enter the password, and tap **Finish**.
 - Tap **Finish** after the network is successfully connected.
 - Tap **Stay at Toolkit** or **Go to Settings**.

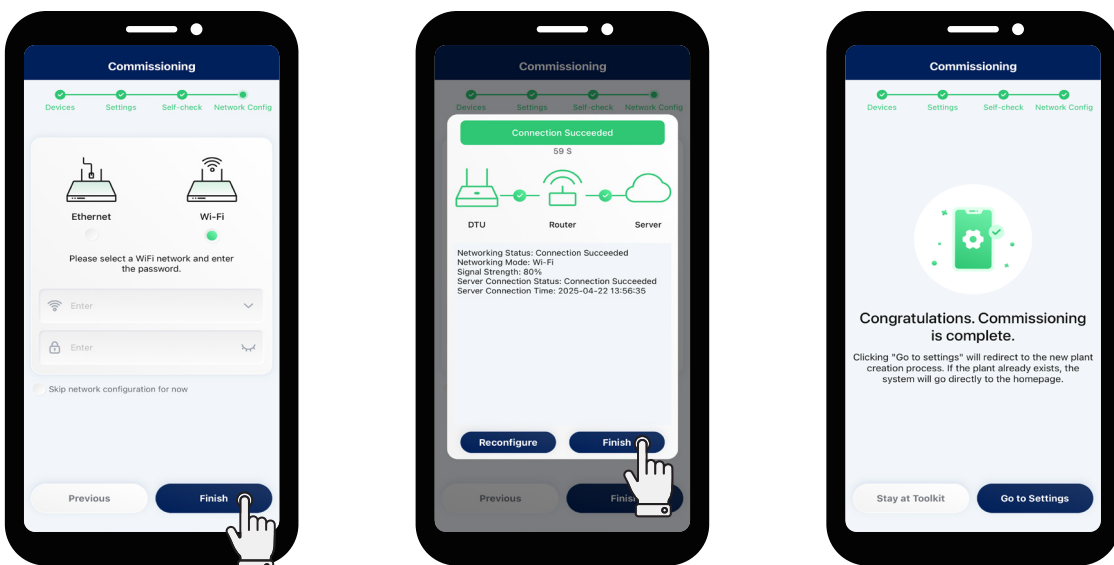

• LAN Mode

NOTE
This mode is only applicable to TGP-ACC-DTS, and the DTS and router are connected via LAN cable.

- a. Select **Ethernet** and tap **Finish**.
- b. Tap **Finish** after the network is successfully connected.
- c. Tap **Stay at Toolkit** or **Go to Settings**.

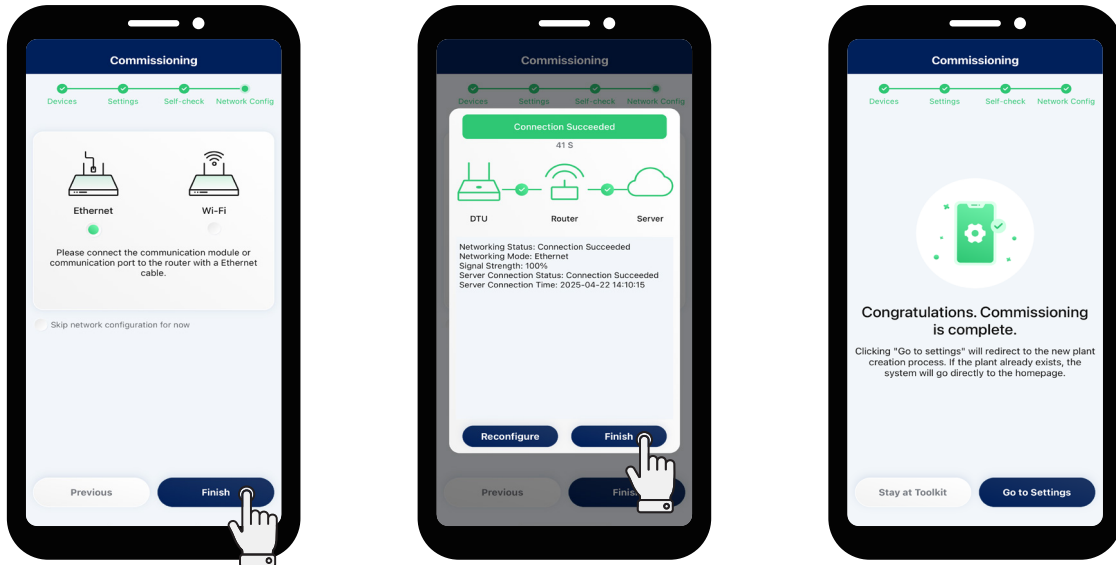

9.3 Set System Parameters

9.3.1 Set Advanced Parameters

Step 1 Tap **O&M** > **Toolkit**, and tap  in the lower right corner.

Step 2 Tap **Advanced Settings** to set parameters of System, Battery, PV, Emergency Power Supply (EPS), and Generator, and tap **Save**.

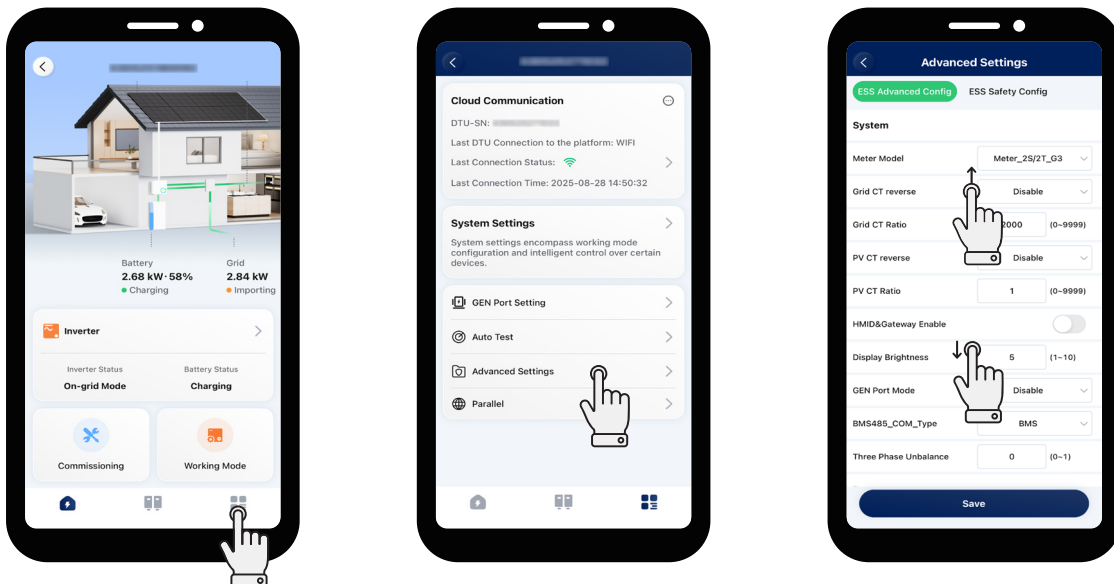

★ System

Parameter	Description	Default Value
Meter Model	<ul style="list-style-type: none"> For a single-phase inverter, please select "Single-phase Meter" or "Three-phase Meter". For a three-phase inverter, please select "Three-phase Meter". <p>NOTE For an inverter used in North America, please select "Two-phase Meter".</p>	No Meter
Grid CT Reverse	<p>Enable it to get correct sampling current when the grid side CT is reversely connected.</p> <p>NOTE CT supports both forward and reverse connections. Disabling it allows forward connection while enabling it allows reverse connection. Double check CT Clamp Arrow direction should be facing in direction of the Utility meter.</p>	Disable
Grid CT Ratio	Set the grid side CT ratio.	2000
PV CT Reverse	Enable it to get correct sampling current when the PV inverter side CT is reversely connected.	Disable
PV CT Ratio	Set the PV inverter side CT ratio.	2000
Display Brightness	Set the brightness of LED indicators.	10
GEN Port Mode	After the generator port is connected to the inverter or generator, select the corresponding option.	Disable
BMS485_COM_Type	<ul style="list-style-type: none"> If the RS485 port is connected to the battery, please select "BMS". If the RS485 port is connected to the microinverter DTU, please select "DTU Com". 	BMS

★ Battery

Parameter	Description	Default Value
Max. Discharging Power	Set the maximum discharging power.	100%
Max. Charging Power	Set the maximum charging power.	100%
Max. SOC	<p>Set the maximum battery capacity as recommended by the battery manufacturer.</p> <p>Recommend to leave at 100%.</p>	100%
Min. SOC	<p>Set the minimum battery capacity as recommended by the battery manufacturer.</p> <p>Recommend 20% for Turogize battery.</p>	10%
Min. SOC Force Charging Power	Set the power to forcibly charge the battery when the battery SOC falls below the set minimum SOC.	200 W

Reserved SOC Force Charging Power	Set the power to charge the battery when the battery SOC falls below reserved SOC. Recommend 20%.	2%
Max. BAT Feed-in Power in Peak Time	Set the maximum value of battery feed-in power in peak time.	100%
Max. Grid Charging Power in Off-peak Time	Set the maximum power to charge the battery from the grid in off-peak time. Recommend 11500W	0 W
Max. BAT Discharging Power in Partial Peak Time	Set the maximum value of battery discharging power in partial peak time.	100%

★ PV

Parameter	Description	Default Value
MPPT Global Scan	If the PV modules are shaded, enable this function.	Disable

★ Emergency Power Supply (EPS)

Parameter	Description	Default Value
EPS Mode	<ul style="list-style-type: none"> When the EPS port is connected, you can select “EPS” or “UPS”. You can select “UPS” when the load keeps power on, and the system will automatically switch between the on-grid mode and the off-grid mode under UPS mode. EPS is characterized by continuous power supply, which means that the loads are powered by bypass under normal power supply, and the DC power will be inverted to supply the loads during power outage, maximizing energy utilization. UPS (Uninterruptible Power Supply) provides stable voltage and frequency, with extremely strict requirements for switching time. UPS not only operates during power outage, but also can output high quality power supply to ensure normal operation of electric equipment in case of abnormal situations such as overvoltage, undervoltage, and surge. When the inverter is used as a PV inverter, select “Disable”. 	UPS
External Bypass	For inverters with an external ATS (EPS) Box, when the external bypass switch is enabled, the inverter EPS port works in the off-grid mode and will not work in the on-grid mode.	Disable
PV Only	In off-grid mode, the hybrid inverter supports operation with PV when there is no battery connection. (This function is not recommended since the system is unstable under this mode)	Disable

★ Generator



Parameter	Range
GEN Location	None/GenSide. To ensure the normal operation of the generator, please select "GenSide".
GEN Signal Setting	Manual or DI/DO. If the generator cannot be controlled by dry contact, please select "Manual". If the generator can be controlled by dry contact, please select "DI/DO".
Min. Run Time	5-60 min
Max. Run Time	6-10 hour
Protection Interval	5-60 min
Synchronize Time	1-20 min
Shutdown Delay	1-20 min
GEN Rated Power	0-20000 W
High Voltage Limit	0-280 V
Low Voltage Limit	0-180 V
High Frequency Limit	0-70 Hz
Low Frequency Limit	0-59 Hz
Max. GEN Charging Power	0-20000 W

9.3.2 Set Export Management Parameters

NOTE

- This function is enabled by default, and the default value of Max. Export Power Limit is 100%.
- ESS refers to a single energy storage inverter or a parallel system.
- The energy storage inverter cannot control the output power of other input devices connected to the grid side. It means that the feed-in power cannot be limited to 0 if other input devices are connected to the grid side.
- If no input device is connected to the grid side, Max. Export Power Limit can be set to 0-100%.

- If no input device is connected to the grid side, and you do not need to limit the feed-in power, disable this function or skip this setting.
- If an input device, such as a micro inverter, is connected to the grid side, and you do not need to limit the feed-in power, disable this function.
- If you need to limit the feed-in power, follow the instructions below to set Max. Export Power Limit.

Step 1 Tap  **O&M** >  **Toolkit**, and tap  in the lower right corner.

Step 2 Tap  **Advanced Settings** > **ESS Safety Config**, and slide your finger down to the bottom.

Step 3 Ensure **Generation Control Function (GCF)** is enabled, and set the value **0 in most cases of** Export Power Limit, and tap **Save**.

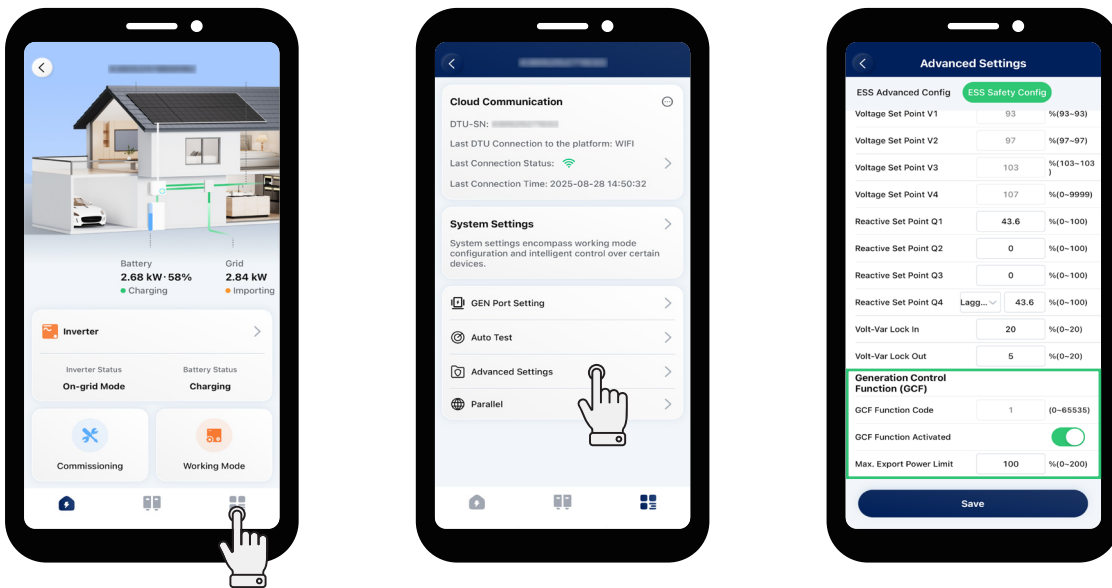

Scenario 1: Max. Export Power Limit is 0

The feed-in power of an Energy Storage System (ESS) is 0. If an input device, such as a micro inverter, is connected to the grid side, its output power cannot be controlled; it will output power according to its logic.

Scenario 2: Max. Export Power Limit is 50%

The maximum allowable feed-in power is 50% of the rated power of ESS. If an input device, such as a micro inverter, is connected to the grid side, it can operate at full power, and the energy storage inverter will adjust the output of ESS in real time according to the set Max. Export Power Limit.

Scenario 3: Max. Export Power Limit is 100%

The maximum allowable feed-in power is 100% of the rated power of ESS. If an input device, such as a micro inverter, is connected to the grid side, it can operate with its full power, and the energy storage inverter will adjust the output of ESS in real time according to the set Max. Export Power Limit.

Scenario 4: Max. Export Power Limit is 150%

The maximum allowable feed-in power is 150% of the rated power of ESS. If an input device, such as a micro inverter, is connected to the grid side, it can operate with its full power, and the energy storage inverter will adjust the output of ESS in real time according to the set Max. Export Power Limit.

9.3.3 Set Working Mode

NOTE

Only one mode can be selected at a time.

If Working mode is changed please allow up to 5 minutes before making any other changes. The data and status shown on home screen may take 5 minutes to reflect the change.

After the commissioning, if you want to change the working mode, follow the instructions below.

Method One

Step 1 Tap **O&M** > **Toolkit**, and tap **Working Mode**.

Step 2 Select one mode, set relevant parameters, and tap **Save**.

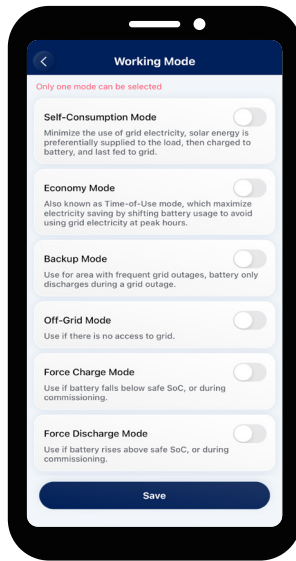
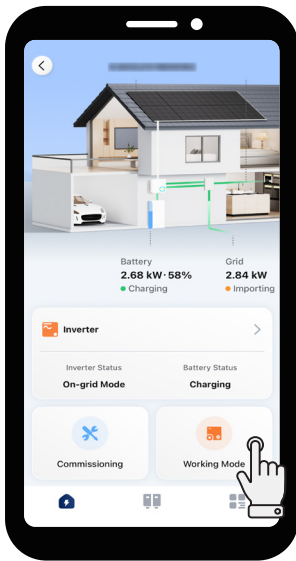

Method Two

Step 1 Tap **O&M** > **Toolkit**, tap in the lower right corner, and tap **System Settings**.

Step 2 Tap **Working Mode**.

Step 3 Select one mode, set relevant parameters, and tap **Save**.

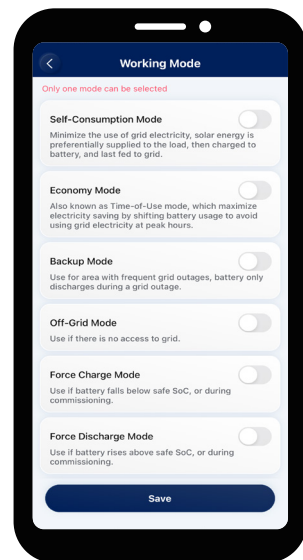
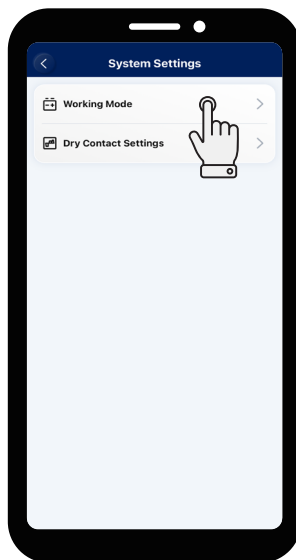
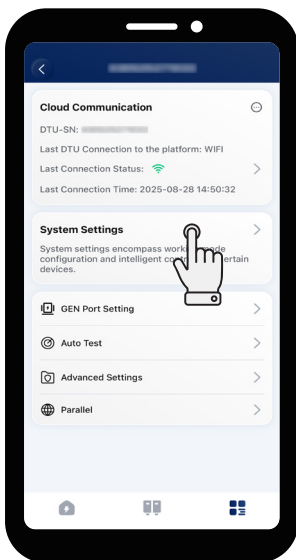

NOTE
Force Charge Mode and **Force Discharge Mode** are only available in the Installer APP.

★ Self-consumption Mode

In the daytime, solar energy supports the loads firstly, and surplus energy is stored in the battery. When the battery is fully charged or reaches the maximum charge power, the surplus energy is fed into the grid (or limited if required). At night, the battery discharges for the loads firstly, and the grid will supply the loads once the battery power is not enough. In this mode, battery cannot be charged from the grid at night.

The self-consumption mode can reduce the use of grid power. Solar energy is preferentially supplied to the loads, charged to the battery, and finally fed into the grid. Users can set the reserved SOC within a certain range. (A small amount of power can be reserved due to infrequent power outages.)

★ Economy Mode

In this mode, battery charging and discharging periods need to be defined. Meanwhile, the battery can be forced to charge from the grid during the preset charging time. For instance, the battery could be charged or discharged according to valley or peak electricity prices. You can set reserved SOC within a certain range (a small amount of power can be reserved due to infrequent power outages), select the type of currency you need, and set different time periods to be more flexible to save costs of electricity. Set the time period for peak, low and partial peak grid prices in different seasons or dates, and you can just add up to four time periods.

★ Backup Mode

Backup mode can be selected when the grid frequently breaks down. The battery will be forced to charge to a set capacity so that it has enough power to support the electricity consumption in daily life when the inverter is in off-grid mode. You can also set the reserved SOC within a certain range.

★ Off-grid Mode

When the system is not connected to the grid, you can choose the off-grid mode.

★ Force Charge Mode

The force charge mode can be used during the commissioning of inverter or when the battery capacity falls below the value of safety SOC. You can set the reserved SOC within a certain range. If the battery capacity is lower than the setting, the battery will be forcibly charged. And You can set the max. charging power of battery if needed. Finally, save the values you have changed.

★ Force Discharge Mode

The force discharge mode can be used during the commissioning of inverter or when the battery capacity rises above the value of safety SOC. You can set the reserved SOC within a certain range. If the battery capacity is higher than the setting, the battery will be forcibly discharged. And you can set the max. discharging power of battery if needed. Finally, save the values you have changed.

9.3.4 Set Dry Contact Function

NOTE

Only one mode can be selected at a time.

Step 1 Tap  O&M >  Toolkit, tap  in the lower right corner, and tap **System Settings**.

Step 2 Tap  **Dry Contact Settings**.

Step 3 Select one mode, set relevant parameters, and tap **Save**.



★ **Earth Fault Alarm**

This function is used for external alarm caused by grounding insulation resistance fault or residual current fault. Disable the external alarm when the load is connected. This function is to produce alarm, not to cause tripping.

★ **Load Control**

Load control can be used according to individual demand. This setting is to control whether the load is working or not. There are five modes available as follows.

- **Manual Mode**
Manually turn on or turn off the dry contact.
- **Scheduled Mode**
Set the time period for the dry contact to work. The dry contact is closed during this set time and disconnected at other times.
- **Intelligent Mode**
Because the energy generated by PV fluctuates a lot, this mode is to make the dry contact avoid being turned on and off frequently. The dry contact will only be turned on when the residual energy generated by the PV exceeds the power set by the load within the set time period. You can set the minimum run time and the nominal power of the dry contact.
- **EPS Port Smart Control**
The unnecessary dry contact will be turned off in off-grid situation when the battery capacity is lower than the set SOC value. You can set the value of protection SOC if needed.
- **Heat Pump Control**
The heat pump control function allows users to add up to four runtimes. According to the set power and battery SOC, it can control the start and stop as well as the power of the SG Ready heat pump, maximizing the PV energy utilization.

Parameter	Description
Start Power	When the average feed-in power is greater than or equal to the start power, the heat pump will be started.
Shutdown Power	When the running time is greater than or equal to the minimum single runtime and the average grid input power is greater than or equal to the shutdown power, the heat pump will be shut down.
Battery Starting SOC	There is an ON/OFF option. The default option is OFF. ON: When the average feed-in power is greater than or equal to the start power or the battery SOC is greater than or equal to the battery start SOC, the heat pump will be started.
Battery Shutdown SOC	When the running time is greater than or equal to the minimum single runtime and the battery SOC is less than the battery shutdown SOC, the heat pump will be shut down.
Min. Single Runtime	The minimum single runtime of the heat pump.
Max. Single-day Runtime	There is an ON/OFF option. The default option is OFF. ON: The heat pump will be shut down when the running time of the day reaches the maximum single-day runtime; it will be started again when the starting condition is reached the next day.
Time Range	Up to 4 operating periods can be set.

★ **Generator Control**

- Exercise Mode

The generator starts regularly during the preset period to ensure the operation of the generator.

Parameter	Description
Frequency	It allows the generator to start regularly at this frequency.
Start Time	It allows the generator to start regularly at this time.
Duration	The generator will stop running after this duration.

- Running Mode

This mode is the off-grid operation mode of the generator, including manual mode and auto mode.

- ▷ Manual Mode

The manual mode is used to turn on or turn off the generator manually.

- ▷ Auto Mode

The auto mode is used to turn on or turn off the generator according to the battery capacity. The auto mode only supports generators controlled by Dry Contact. Otherwise, please select the manual mode.

Parameter	Description
GEN Start SOC	In off-grid mode, start the generator when the battery capacity is lower than the safety SOC.
GEN Shutdown SOC	In generator mode, shut down the generator when the battery capacity is higher than the safety SOC.
Quiet Time	During the quiet time, the generator is disabled. If you set this time, it will affect the normal use of electricity.

- Battery Charge Time

Parameter	Description
Battery Charge Time	The generator will charge the battery during the preset period. Please choose the time period when the PV power is low to avoid wasting PV power.

9.4 Upgrade the Firmware

NOTE

During the firmware upgrade, do not power off the device.

When you enter the plant overview interface, there will be a pop-up window if there is a new firmware version.

Method One

Step 1 Tap the target plant.

Step 2 Tap **Upgrade**.

Step 3 Tap **Upgrade**.

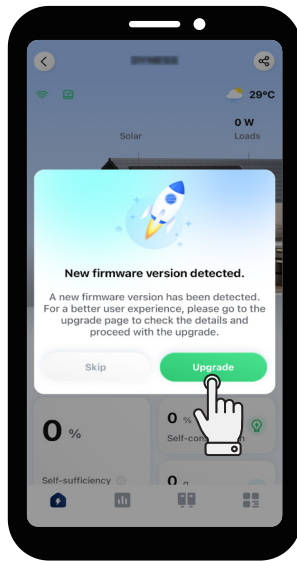
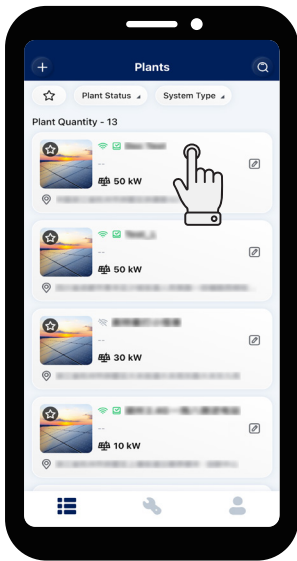

Method Two

If you have tapped **Skip** to perform other operations, you can also follow the instructions below to upgrade the firmware.

Step 1 Tap  in the lower right corner.

Step 2 Tap  **Firmware Upgrade** > **Upgrade**.

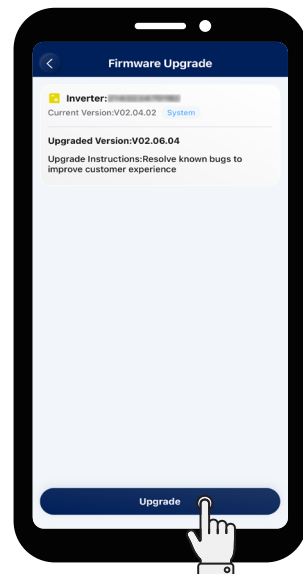
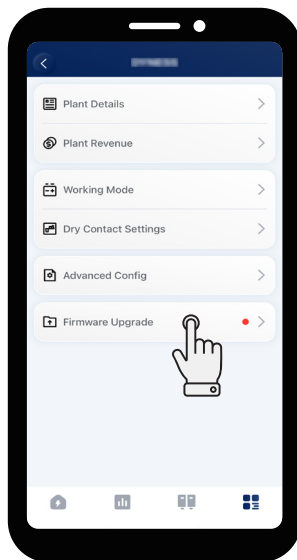
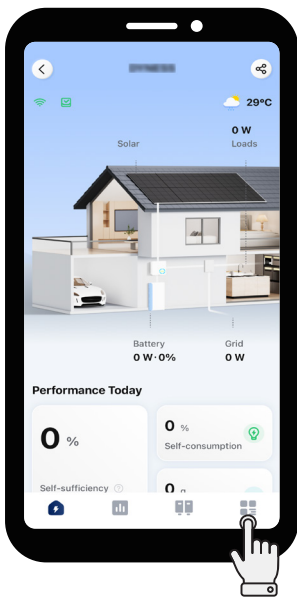

9.5 ESS Operating Modes Setting

ESS Operating Mode is only for the United States, Canada, and Mexico. It is to restrict the energy exchange between the Area EPS and the energy storage sub-system (ESS). TuroGize energy storage system has two ESS operating modes, Export Only Mode and Import Only Mode.

9.5.1 Export Only Mode

If the Export Only Mode is chosen, the ESS may export active power to the Area EPS during discharging but shall not import active power from the Area EPS for ESS charging purposes. **Under this mode, please change the Generation Control Function (GCF) to disabled. (Slide switch in app should be off). Set the Max. Export Power Limit accordingly.**

9.5.2 Import Only Mode

If the Import Only Mode is chosen, the ESS may import active power from the Area EPS for charging purposes but shall not export active power from the ESS to the Area EPS. **Under this mode, please change the GCF function slider in the app to the on position. Set Max. Export Power Limit to 0 (zero).**

9.5.3 APP Setting

Step 1 Select  Plant, find the target plant, and click Details icon

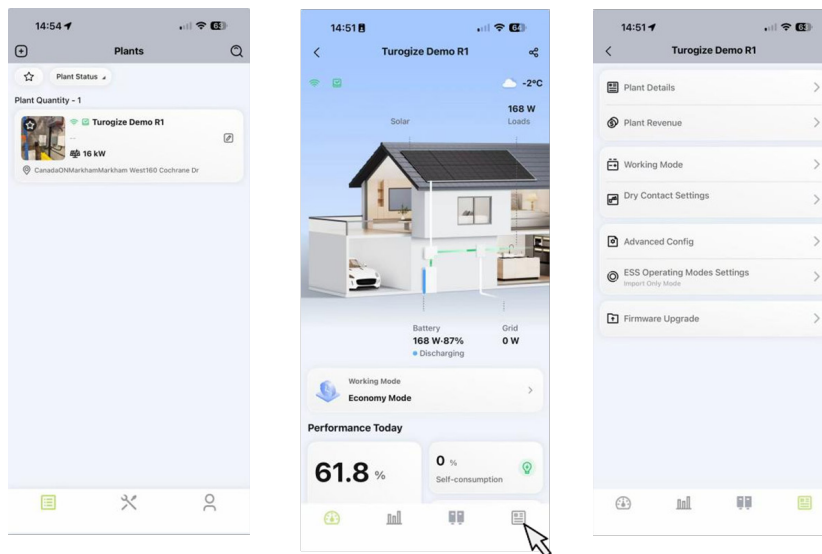

Step 2 Click **ESS Operating Modes Settings**

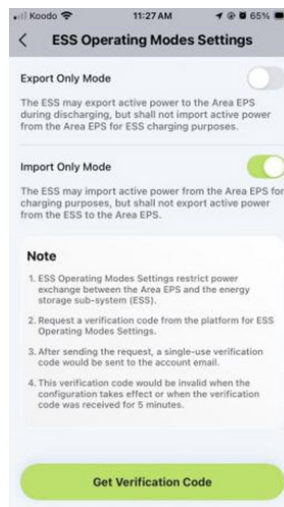

Step 3 Enable **Export Only Mode** or Import Only Mode, click **Get Verification Code**, and click **Send**.

NOTE

Once the Export Only Mode or Import Only Mode is set, it will be locked and cannot be modified.

Step 4 Enter the verification code you received and click **Configure**.

NOTE

- The verification code you received is a one-time password (OTP)
- The verification code would be invalid when the configuration takes effect or when the verification code is received for 5 minutes.
- Below see that the OTP will come from the below indicated email address Check Junk mail folder as it may be there.

monitor-noreply@solarer.net

To: ☒ Support



Plant name: Turogize Demo R1

Your verification code is 661945 (valid within 5 minutes).

To ensure the security of your account, please do not provide this verification code to anyone.

This email is sent automatically by the system, please do not reply directly.

10 System Maintenance

10.1 System Power-off

NOTICE

Wait at least 5 minutes after the LED indicators turn off to release the internal energy.

- Step 1** Stop the inverter from working via the TGPower App.
- Step 2** Disconnect the DC breaker between the inverter and the battery if the inverter is connected to the battery.
- Step 3** Disconnect the AC breaker between the inverter and the grid.
- Step 4** Rotate the DC switch to "OFF" if the inverter is connected to the PV strings.
- Step 5** Check whether the inverter indicators are off.

10.2 Routine Maintenance

To ensure that the inverter can operate for a long time, it is recommended to perform the following maintenance items. Make sure that all maintenance items are performed after the inverter is powered off.

Check Item	Check Method	Maintenance Interval
System Cleanliness	Periodically check the heat sinks to ensure that there are no obstacles and dust.	Once every 6 months
System Operation Status	<ul style="list-style-type: none"> • Check whether the inverter is damaged or deformed. • Check whether there is an abnormal sound when the inverter is working. • Check whether the inverter parameters are set correctly. 	Once every 6 months
Electrical Connection	<ul style="list-style-type: none"> • Check whether the cables are firmly connected and intact; in particular, ensure that the parts being contacted with the metal surface are not scratched. • Check whether the waterproof plugs or covers of unused ports are firmly in place. 	The first inspection is 3 months after the first installation, and the subsequent inspections can be carried out once every 6 to 12 months.
Grounding Reliability	Check whether the ground cables are firmly connected.	The first inspection is 3 months after the first installation, and the subsequent inspections can be carried out once every 6 to 12 months.

10.3 Troubleshooting

When the system is in alarm, please log in to the TGPower App to review. The possible causes and their troubleshooting are shown as follows.

Display	Possible Cause	Handling Suggestions
Grid Overvoltage	The grid voltage is higher than the permissible range.	Generally, the inverter will reconnect to the grid after the grid recovers. If the alarm occurs frequently: 1. Make sure the ESS safety configuration of the inverter is set correctly. 2. Make sure that the grid voltage in your area is stable and within the normal range. 3. Check whether the cross-sectional area of the AC cable meets the requirement. 4. If the alarm persists, contact TuroGize technical support team.
Grid Undervoltage	The grid voltage is lower than the permissible range.	Generally, the inverter will reconnect to the grid after the grid recovers. If the alarm occurs frequently: 1. Make sure the ESS safety configuration of the inverter is set correctly. 2. Make sure that the grid voltage in your area is stable and within the normal range. 3. Check whether the AC cable is firmly in place. 4. If the alarm persists, contact TuroGize technical support team.
Grid Overfrequency	The grid frequency is higher than the permissible range.	Generally, the inverter will reconnect to the grid after the grid recovers. If the alarm occurs frequently: 1. Make sure the ESS safety configuration of the inverter is set correctly. 2. Make sure that the grid frequency in your area is stable and within the normal range. 3. If the alarm persists, contact TuroGize technical support team.
Grid Underfrequency	The grid frequency is lower than the permissible range.	
No Grid	The inverter detects that there is no grid connected.	Generally, the inverter will reconnect to the grid after the grid recovers. If the alarm occurs frequently: 1. Check whether the grid supply is reliable. 2. Check whether the AC cable is firmly in place. 3. Check whether the AC cable is correctly connected. 4. Check whether the AC circuit breaker is disconnected. 5. If the alarm persists, contact TuroGize technical support team.
RCD Fault	The residual leakage current is too high.	1. The alarm can be caused by high ambient humidity, and the inverter will reconnect to the grid after the environment is improved. 2. If the environment is normal, check whether the AC and DC cables are well insulated. 3. If the alarm persists, contact TuroGize technical support team.
PV Reverse Connection	The inverter detects that the PV strings are reversely connected.	1. Check whether the corresponding string is of reverse polarity. If so, disconnect the DC switch and adjust the polarity when the string current drops below 0.5 A. 2. If the alarm persists, contact TuroGize technical support team.

PV Undervoltage	The PV voltage is lower than the permissible range.	<ol style="list-style-type: none"> 1. Check whether the DC cable is firmly in place. 2. Check whether there is a PV module shaded. If so, remove the shade and ensure the PV module is clean. 3. Check whether the PV module is in abnormal aging. 4. If the alarm persists, contact TuroGize technical support team.
PV Overvoltage	The PV voltage is higher than the permissible range.	<ol style="list-style-type: none"> 1. Check the specification and numbers of corresponding string PV modules. 2. If the alarm persists, contact TuroGize technical support team.
Over Temperature	The temperature inside the inverter is higher than the permissible range.	<ol style="list-style-type: none"> 1. Make sure that the installation complies with the instructions from the User Manual. 2. Check whether the alarm "Fan Fault" occurs. If so, replace the faulty fan. 3. If the alarm persists, contact TuroGize technical support team.
ISO Fault	The insulation impedance of the PV string to the ground is too low.	<ol style="list-style-type: none"> 1. Use a multimeter to determine if the resistance between the earth and the inverter frame is close to zero. If not, please ensure that the connection is good. 2. If the humidity is too high, an isolation fault may occur. Attempt to restart the inverter. If the fault persists, check it again when the weather turns fine. 3. Check the resistance to ground from the PV module/cable. Take corrective measures in case of leading to a short circuit or damaged insulation layer. 4. If the alarm persists, contact TuroGize technical support team.
Arc Fault	The inverter detects that there is an arc fault.	<ol style="list-style-type: none"> 1. Disconnect the DC switch and check whether DC cables are damaged and whether the wiring terminals are loose or in poor contact. If so, take corresponding corrective measures. 2. After taking corresponding measures, reconnect the DC switch. 3. If the alarm persists, contact TuroGize technical support team.
EPS Load Overpower	The EPS load power is higher than the permissible range.	<ol style="list-style-type: none"> 1. Reduce the power of EPS loads, or remove some EPS loads. The inverter will restart automatically. 2. If the alarm persists, contact TuroGize technical support team.
Meter Reverse Connection	The inverter detects that the Meter or CT is reversely connected.	<ol style="list-style-type: none"> 1. Make sure that the installation complies with the instructions from the User Manual. 2. If the alarm persists, contact TuroGize technical support team.
Meter Communication Fault	The inverter detects that there is a meter communication fault.	<ol style="list-style-type: none"> 1. Check whether the Meter communication cable and terminal are abnormal. 2. Reconnect the Meter communication cable. 3. If the alarm persists, contact TuroGize technical support team.
Battery Reverse Connection	The inverter detects that the battery wirings are reversely connected.	<ol style="list-style-type: none"> 1. Check the battery for polarity correctness, and correct it if necessary. 2. If the alarm persists, contact TuroGize technical support team.
Battery Voltage Fault	The battery voltage is higher than the permissible range.	<ol style="list-style-type: none"> 1. Check if the battery input voltage is within the normal range. 2. If the alarm persists, contact TuroGize technical support team.

BMS Communication Fault	The inverter detects that there is a BMS communication fault.	<ol style="list-style-type: none"> 1. Check whether the BMS communication cable and terminal are abnormal. 2. Reconnect the BMS communication cable. 3. If the alarm persists, contact TuroGize technical support team.
BMS Battery Alarm	The inverter detects that there is a battery fault from BMS.	Try to restart the battery. If the fault persists, contact the battery manufacturer.
BMS Battery Fault	The inverter detects that there is a battery fault from BMS.	Try to restart the battery. If the fault persists, contact the battery manufacturer.
Relay Self-check Fault	The inverter detects that there is a relay self-check fault.	Try to restart the inverter. If the fault persists, contact TuroGize technical support team.

11 Decommissioning

11.1 Removing the Product

Step 1 Power off the product as described in [10.1 System Power-off](#).

Step 2 Disconnect all cables.

Step 3 Remove the DTS and the smart meter.

Step 4 Remove the inverter from the wall, remove the bracket if necessary.

11.2 Packing the Product

If the original package is available, put the product and its accessories into the package and keep it in a dry and proper place.

If the original package is not available, put the product and its accessories into a suitable package. The package should be easy to remove, can bear the weight of the product, and can be sealed properly.

11.3 Disposing of the Product

If the inverter can not be used and needs to be disposed of, dispose of the inverter and its accessories in accordance with relevant regulations.

12 Technical Datasheet

Model	TGP-INV-HY-LV-11.5
Battery	
Battery type	Li-ion/Lead-acid
Battery voltage range (V)	40-60
Max. charge/discharge current (A)	200/200
Max. charge/discharge power (W)	9600/9600
Charging strategy for Li-ion battery	Self-adaption to BMS
Charging curve	3 Stages/Equalization
External temperature sensor	Optional
Communication	CAN
PV Input	
Recommended max. PV power (W)	14400
Max. input voltage (V)	550
Rated voltage (V)	380
Start-up voltage (V)	150
MPPT voltage range (V)	125-500
Max. input current (A)	32/32
Max. short circuit current (A)	40/40
MPPT number/Max. input strings number	2/4
AC Input and Output (On-grid)	
Rated output power (W) On-grid	11520
Max. output apparent power (VA)	11520
Max. input power (W)	19200
Rated AC output voltage/Range (V)	240, 211-264/208, 183-229 ⁽¹⁾
Rated grid frequency (Hz)	60
Max. output current (A)	48
Max. input current (A)	80
Power factor	>0.99 (0.8 leading ... 0.8 lagging)
THDi (@rated output)	<3%
AC Output (Off-grid)	
Rated output power (W)	9600
Max. output apparent power (VA) ⁽²⁾	19200, 10s
Back-up switch time (ms)	<2 (single machine operation)
Rated output voltage (V)	120/240 (split phase), 120/208 ⁽¹⁾
Rated output frequency (Hz)	60
Max. continuous output current (A)	40
THDv (@linear load)	<3%

Efficiency	
MPPT efficiency	99.90%
Max. efficiency	97.60%
CEC efficiency	97.00%
Max. battery discharge to AC efficiency	95.00%
Protection	
Anti-islanding protection	Integrated
PV arc fault detection	Integrated
PV string input reverse polarity protection	Integrated
Compliant MLRSD products	Integrated
Insulation resistor detection	Integrated
Residual current monitoring unit	Integrated
AC overcurrent protection	Integrated
AC short current protection	Integrated
AC overvoltage and undervoltage protection	Integrated
Surge protection	DC Type II/AC Type III
General	
Dimensions (W × H × D)	19.8 × 29.1 × 7.95 inch (502 × 740 × 202 mm)
Weight	90.4 lbs (41 kg)
Mounting	Wall mounting
Operating temperature	-13°F to +149°F (>113°F, derating)/-25°C to +65°C (>45°C, derating)
Relative humidity	0-95%, no condensing
Cooling	Natural convection
Topology (Solar/Battery)	Transformerless/High-frequency isolation
Altitude	≤6562 ft (2000 m)
Protection degree	Type 4X
Noise (dB)	<40
User interface	LED, App
Digital input/output	1 × DI, 2 × DO
Max. parallel	10
Communication	RS485, optional: Wi-Fi/Ethernet/4G ⁽³⁾
Warranty	10 Years
Certifications and Standards	
Grid connection standard	IEEE 1547-2018, IEEE 1547.1-2020, SRD2.0
Safety/EMC standard	UL 1741, CSA C22.2 No.1071, UL 1741 CRD, UL 1741 SB, FCC Part 15 Class B
AFCI	UL 1699B
Software approval	UL 1998

(1) For 240 V, the grid profile is US_IEEE1547; for 208 V, the grid profile is IEEE1547_208V.

(2) Can be achieved only if PV and battery power are sufficient.

(3) The DTS-Ethernet and DTS-4G solutions will be coming soon.

13 Appendix 1: Power Quality Response Modes

1. Voltage Trip

When the power grid voltage is abnormal, the inverter can be turned off for a certain period of time.

Shall trip function	Default setting		Ranges of allowable settings	
	Voltage (V)	Clearing time (s)	Voltage (V)	Clearing time (s)
OV2	1.20	0.16	Fix at 1.2	Fix at 0.16
OV1	1.10	13.0	1.10-1.20	1.0-13.0
UV1	0.88	21.0	0.0-0.88	2.0-50.0
UV2	0.5	2.0	0.0-0.50	0.16-21.0

2. Consecutive HVRT_240 V&120 V

The ability of a generating unit or generating plant to stay connected during voltage dips or swells.

Voltage range (p.u.)	Operating mode/ response	Minimum ride through time (s)	Maximum response time (s) (design criteria)
$V > 1.20$	Cease to Energize ⁽²⁾	N/A	0.16
$1.10 < V \leq 1.20$	Momentary Cessation ⁽³⁾	12	0.083
$0.88 \leq V \leq 1.10$	Continuous Operation	Infinite	N/A
$0.70 \leq V < 0.88$	Mandatory Operation	20	N/A
$0.50^{(1)} \leq V < 0.70$	Mandatory Operation	10	N/A
$V < 0.50^{(1)}$	Momentary Cessation	1	0.083

(1): Cessation of current exchange of DER with Area EPS in not more than the maximum specified time and with no intentional delay. This does not necessarily imply disconnection, isolation, or a trip of the DER. This may include momentary cessation or trip.

(2): Temporarily cease to energize an EPS, while connected to the Area EPS, in response to a disturbance of the applicable voltages or the system frequency, with the capability of immediately restoring output of operation when the applicable voltages and the system frequency return to within defined ranges.

(3): The voltage threshold between mandatory operation and momentary operation may be changed by mutual agreement between the Area EPS operator and DER operator.

3. Frequency Trip_240 V

When the power grid frequency is abnormal, the inverter can be shut down for a certain period of time.

Shall trip function	Default setting		Ranges of allowable settings	
	Frequency (Hz)	Clearing time (s)	Frequency (Hz)	Clearing time (s)
OF2	62.0	0.16	61.8-66.0	0.16-1000
OF1	61.2	300.0	61.0-66.0	180.0-1000
UF1	58.5	300.0	50.0-59.0	180.0-1000
UF2	56.5	0.16	50.0-57.0	0.16-1000

4. H/LFRT

The ability of a generating unit or generating plant to stay connected during frequency dips or swells.

Frequency range (Hz)	Operating mode	Minimum time (s)
$f > 62.0$	N/A	N/A
$61.2 < f \leq 61.8$	Mandatory Operation	299
$58.8 \leq f \leq 61.2$	Continuous Operation	Infinite
$57.0 \leq f < 58.8$	Mandatory Operation	299
$f < 57.0$	N/A	N/A

5. Volt-Var (Default)

The inverter will change reactive output power based on voltage change.

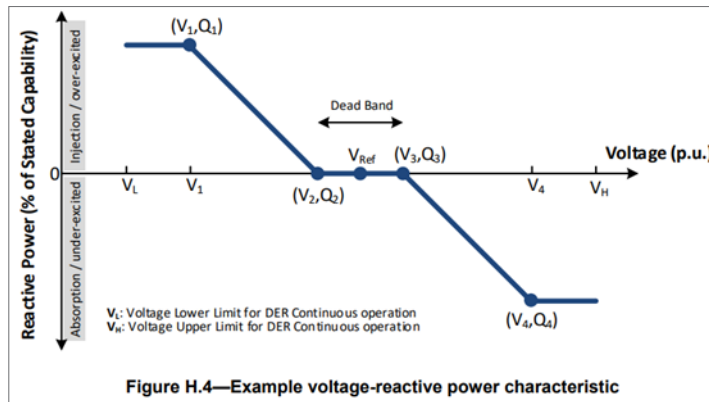

Setting point	Voltage range	Voltage default	Q range/default
Vref	$0.95V_n - 1.05V_n$	V_n	/
(V1, Q1)	$(V_{ref} - 0.18V_n) - (V_2 - 0.02V_n)$	$V_{ref} - 0.08V_n$	$(0 - 60\%) S_n / +40\% S_n$
(V2, Q2)	$(V_{ref} - 0.02V_n) - V_{ref}$	$V_{ref} - 0.02V_n$	$(-60\% - 60\%) S_n / 0$
(V3, Q3)	$V_{ref} - (V_{ref} + 0.03V_n)$	$V_{ref} + 0.02V_n$	$(-60\% - 60\%) S_n / 0$
(V4, Q4)	$(V_3 + 0.02V_n) - (V_{ref} + 0.18V_n)$	$V_{ref} + 0.08V_n$	$(-60\% - 0) S_n / -44\% S_n$

Tr: Open loop response time, default 5s, range 1-90s.

6. Vol-Watt (Default)

The inverter will change reactive output power based on active power change.

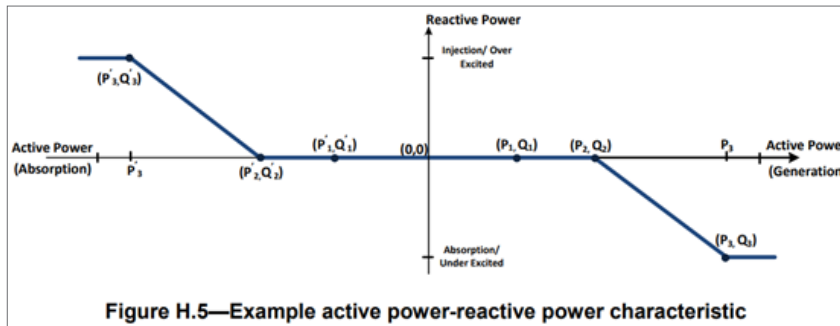

Active power-reactive power parameters	Ranges of allowable settings	Default settings
P3	$(P2+0.1 \text{ Prated})-\text{Prated}$	Prated
P2	0.4 Prated-0.8 Prated	50%Prated
P1	$P_{\text{min}}-(P2-0.1 \text{ Prated})$	20%Prated
P'1	$(P'2-0.1 P'_{\text{rated}})-P'_{\text{min}}$	-20%Prated
P'2	0.8 P'rated-0.4 P'rated	-50%Prated
P'3	$P'_{\text{rated}}-(P'2+0.1 P'_{\text{rated}})$	-Prated
Q3	-60%Sn-60%Sn	-44%Prated
Q2	-60%Sn-60%Sn	0
Q1	-60%Sn-60%Sn	0
Q'1	-60%Sn-60%Sn	0
Q'2	-60%Sn-60%Sn	0
Q'3	-60%Sn-60%Sn	44%Prated

NOTE

- Prated is the nameplate active power rating of the DER.
- P'rated is the maximum active power that the DER can absorb.
- Pmin is the minimum active power output of the DER.
- P'min is the minimum, in amplitude, active power that the DER can absorb.
- P' parameters are negative in value.
- The maximum DER response time to maintain constant reactive power shall be 10s or less.

7. Vol-Watt (Default)

The inverter will change active power output power based on voltage change.

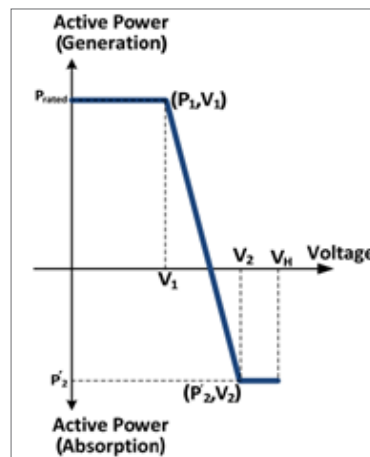

Voltage-active power parameters	Ranges of allowable settings	Default values for DER
V1	1.05Vn-1.09Vn	1.06Vn
P1	N/A	Prated
V2	(V1+0.01Vn)-1.10Vn	1.1Vn
P'2	0-P'rated	0
Open loop response time	0.5s-60s	10s

8. Fre-Watt (Default)

The inverter will change active power output power based on frequency change.

Parameter	Default settings	Ranges of allowable settings
dbOF, dbUF (Hz)	0.036	0.017 ⁽¹⁾ -1.0
kOF, kUF	0.05	0.03-0.05
Response time (small-signal) (s)	5	1-10

(1): A deadband of less than 0.017 Hz shall be permitted.

14 Appendix 2: HECO

1. Fre-Watt (Default)

The inverter will change active power output based on frequency change.

Parameter	Default settings	Ranges of allowable settings
dbOF, dbUF (Hz)	0.036	0.017-1.0
kOF, kUF	0.07	0.02-0.07
Response time (small-signal) (s)	5	0.2-10

2. H/LFRT (Default)

The ability of a generating unit or generating plant to stay connected during frequency dips or swells.

Frequency range (Hz)	Operating mode	Minimum time (s)
$f > 65.0$	N/A	N/A
$63.0 < f \leq 65.0$	Mandatory Operation	299
$57.0 \leq f \leq 63.0$	Continuous Operation	Infinite
$50.0 \leq f < 57.0$	Mandatory Operation	299
$f < 50.0$	N/A	N/A

TUROGIZE

TuroGize Inc.

 160 Cochrane Dr, Markham, ON L3R 9S1

 TuroGize.com

 support@TuroGize.com

